

环保物料

- Specifications(规格):
- Voltage rating(额定电压): 250V AC / DC
 - Current rating(额定电流): 6.5A AC / DC
 - Withstanding voltage(耐压值): 800V AC/minute
 - Temperature range(工作温度): -25°C~+85°C
 - Insulation resistance(绝缘电阻): 1000M
 - Contact resistance(接触电阻): 20m
 - After environmental testing(环境测试后): 40m
- Wafer (针座)
- Part No. (料号): M2016WRS-XX
 - Poles (PIN数): 2-6
 - Material (材质): PA4T UL 94V-0
 - Pin针: Brass (黄铜)
 - Finish: Gold Flash (镀金)
 - 定位片: Brass (黄铜)
 - Finish: Tin-Plated (镀锡)

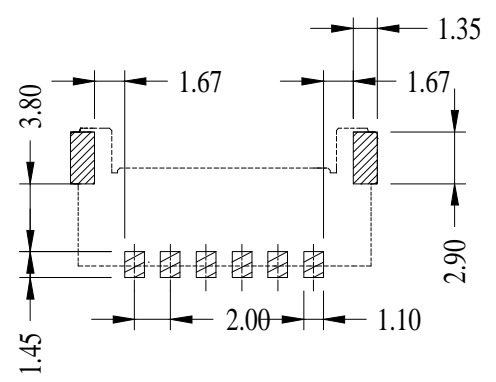
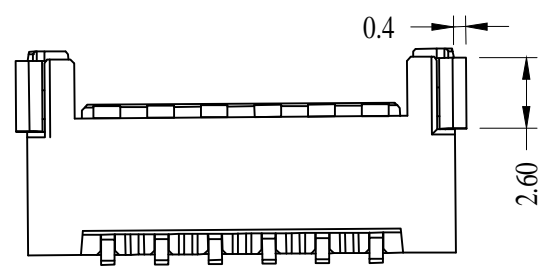
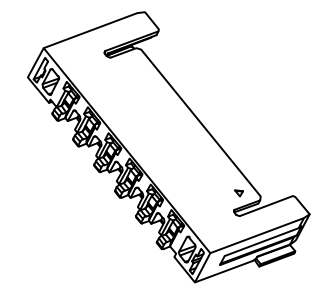
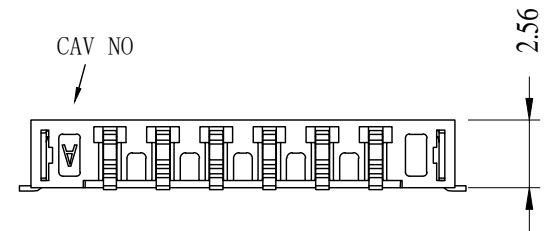
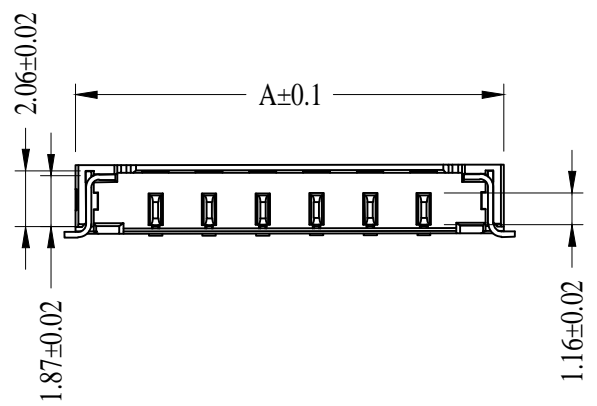
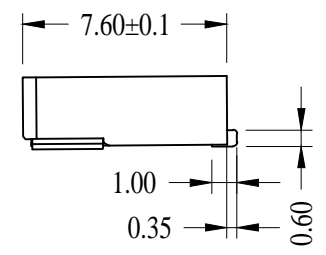
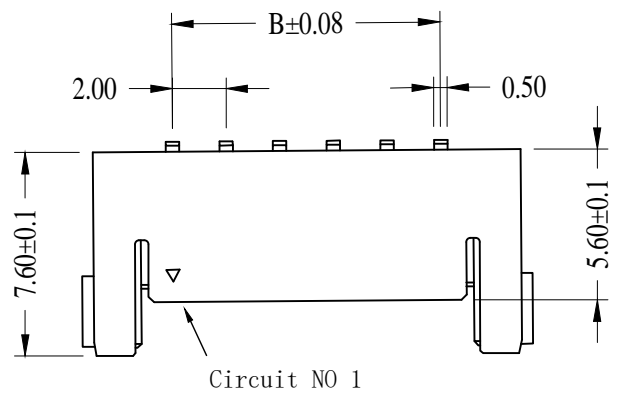

Contacts	Dimensions(mm)	
	Dim A	Dim B
2	7.65	2
3	9.95	4
4	11.95	6
5	13.95	8
6	15.95	10
7	17.95	12
8	19.95	14
9	21.95	16

						一般公差 GENERAL TOLERANCE	东莞市翰皓精密电子有限公司 Dongguan HanHao Precision Electronics Co.,Ltd				料号 PART NO M2016WRS-XX			
						.X ±0.3	核准 APPD				品名 TITLE 2.0 mm Crimp Style connectors			
						.XX ±0.2	审核 CHK				日期 DATA			
						.XXX ±0.1	绘图 DR				单位 UNIT			
2021/05/14	A	B	修改图框格式			角法 PROJECT	YANLING				比例 SCALE			
日期 DATE	旧版次 OLD REV	新版次 NEW REV	变更内容 DESCRIPTION			角法 PROJECT	SUCCESS				图号 NUMBER			
						角法 PROJECT	刘艳				版次 REV			
						角法 PROJECT	2020/05/03				A-097			
						角法 PROJECT	MM				B			

环保物料

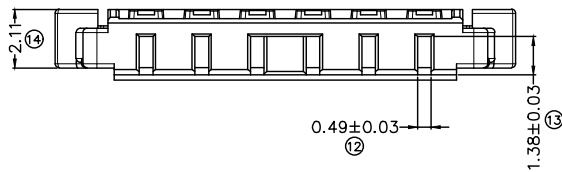
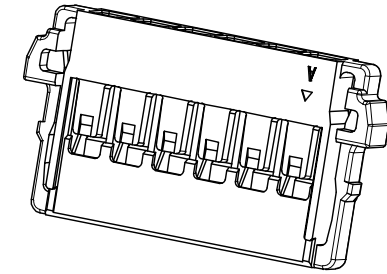
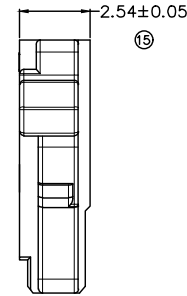
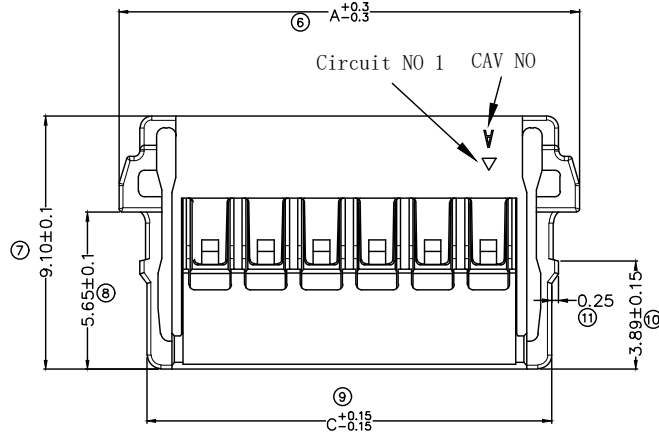
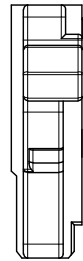
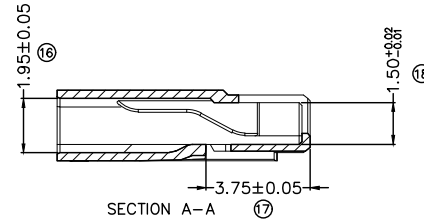
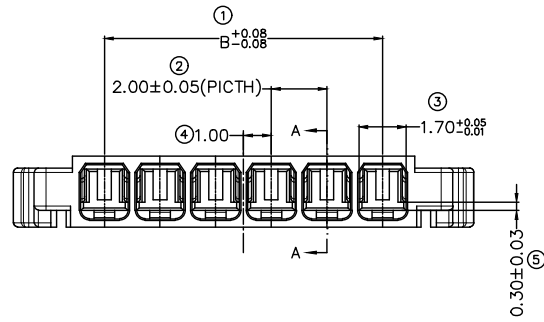

- Specifications(规格):
 - Voltage rating(额定电压): 250V AC / DC
 - Current rating(额定电流): 6.5A AC / DC
 - Withstanding voltage(耐压值): 800V AC/minute
 - Temperature range(工作温度): -25°C~+85°C
 - Insulation resistance(绝缘电阻): 1000M
 - Contact resistance(接触电阻): 20m
 - After environmental testing(环境测试后): 40m
- Housing (针座)
 - Part No. (料号): M2016H-XX
 - Poles (PIN数): 2-6
 - Material (材质): PA66 UL 94V-0

Contacts	Dimensions(mn)			Q'ty/bag
	Dim A	Dim B	Dim c	
2	8.55	2	6.55	1000
3	10.55	4	8.55	1000
4	12.55	6	10.55	1000
5	14.55	8	12.55	1000
6	16.55	10	14.55	1000
7	18.55	12	16.55	1000
8	20.55	14	18.55	1000
9	22.55	16	20.55	1000
10	24.55	18	22.55	1000
11	26.55	20	24.55	1000
12	28.55	22	26.55	1000
13	30.55	24	28.55	1000
14	32.55	26	30.55	1000
15	34.55	28	32.55	1000
16	36.55	30	34.55	1000

						一般公差 GENERAL TOLERANCE .X ±0.3 .XX ±0.2 .XXX ±0.1				东莞市翰皓精密电子有限公司 Dongguan HanHao Precision Electronics Co.,Ltd				料号 PART NO M2016H-XX											
						核准 APPD YANLING				审核 CHK SUCCESS				绘图 DR 刘艳				日期 DATA 2020/05/03				品名 TITLE 2.0 mm Crimp Style connectors			
2021/05/14	A	B	修改图框格式																						
日期 DATE	旧版次 OLD REV	新版次 NEW REV	变更内容 DESCRIPTION			审核 CHK	核准 APPD	角法 PROJECT	PROJECT	YANLING	SUCCESS	刘艳	2020/05/03	单位 UNIT MM	比例 SCALE 1/1	图号 NUMBER A-189	版次 REV B								

环保物料

■ Specifications(规格):

- Voltage rating(额定电压): 250V AC / DC
- Current rating(额定电流): 6.5A AC / DC
- Withstanding voltage(耐压值): 800V AC/minut
- Temperature range(工作温度): -25°C~+85°C
- nsulation resistance(绝缘电阻): 1000M
- Contact resistance(接触电阻): 20m
- After environmental testing(环境测试后): 40m
- Finish: Half Gold

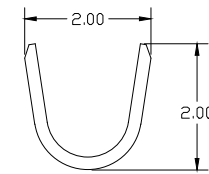
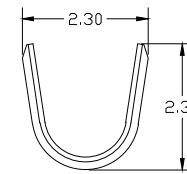
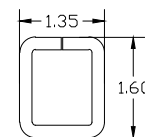
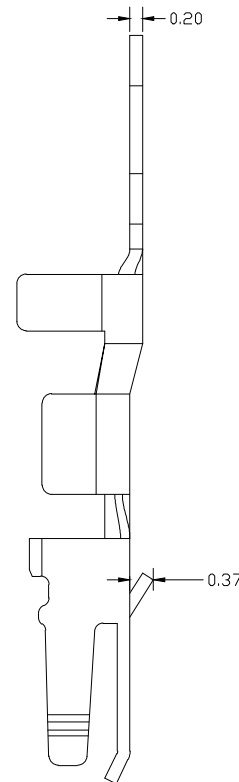
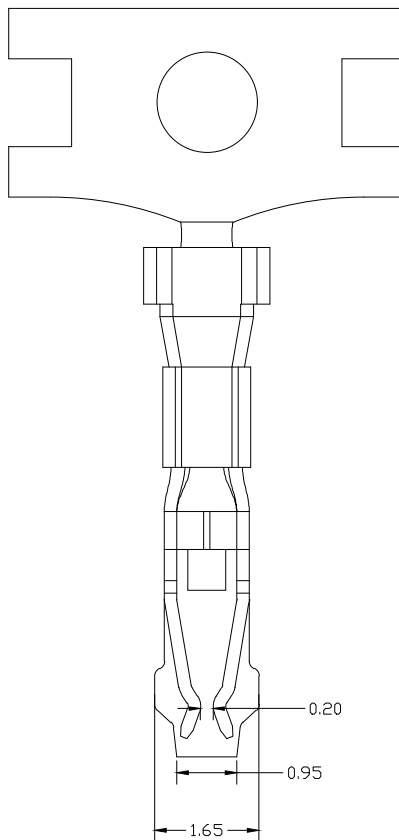
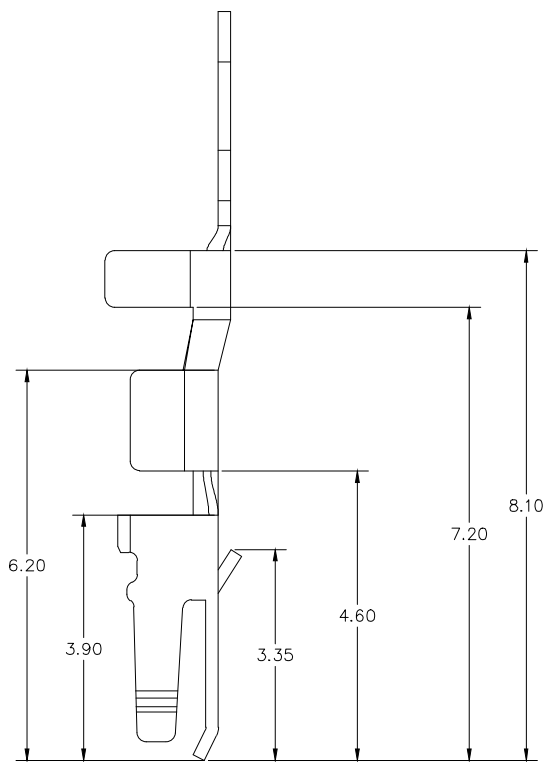

高脚

低脚

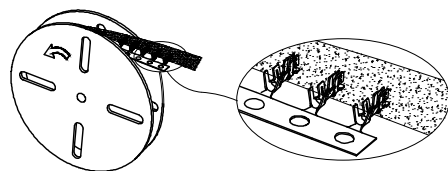

M2016TA	Phosphor Bronze	AWG#24-26	M2016H
M2016TB	Phosphor Bronze	AWG#20-22	M2016H
PART NO	Material	Wire Range	Used In HHB Housing

一般公差
GENERAL TOLERANCE
. X ±0.3
. XX ±0.2
. XXX ±0.1

东莞市翰皓精密电子有限公司
Dongguan HanHao Precision Electronics Co.,Ltd

料号 PART NO
M2016TG

品名 TITLE
2.0 mm Crimp Style connectors

核准 APPD 审核 CHK 绘图 DR 日期 DATA

YANLING SUCCESS 刘艳 2022/05/03

单位 UNIT 比例 SCALE 图号 NUMBER 版次 REV

MM 1/1 A-189 B

日期 DATE 旧版次 OLD REV 新版次 NEW REV 变更内容 DESCRIPTION 审核 CHK 核准 APPD

角法 PROJECT

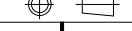

1 2 3 4 5 6 7 8

F E D C B A

F E D C B A