

RoHS

本产品符合我司QA-3-04-005  
环境管理物质标准规范

零件工程图

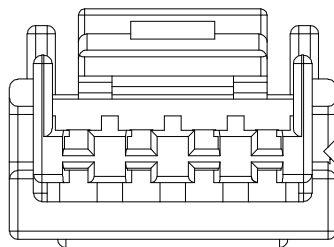
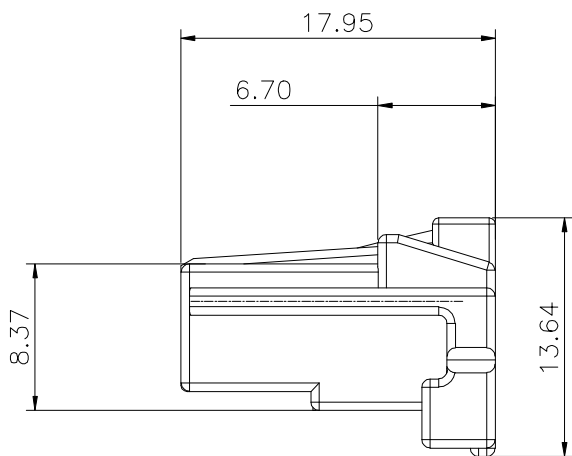
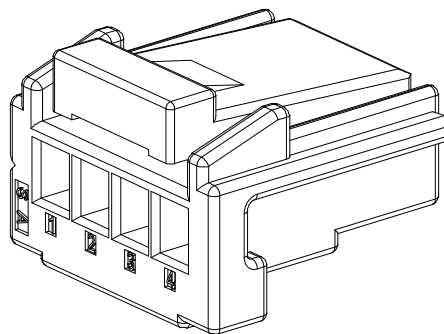
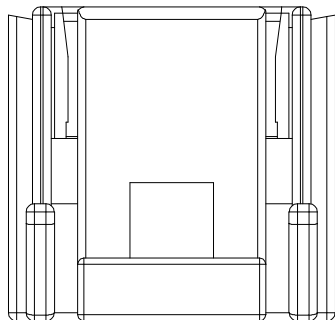

Specifications(规格) :

- Voltage rating(额定电压): 125V AC / DC
- Current rating(额定电流): 2A AC / DC
- Withstanding voltage(耐压值): 500V AC/minute
- Temperature range(工作温度): -40°C~+105°C
- Insulation resistance(绝缘电阻):  $\geq 1000M\Omega$
- Contact resistance(接触电阻):  $\leq 20m\Omega$
- After environmental testing(环境测试后):  $\leq 40m\Omega$

J1504 H F-lxXX- P T N B R 01 F

① ② ③ ④ ⑤ ⑥ ⑦ ⑧ ⑨ ⑩

- ① 系列编码:
- ② 类别编码: H-Housing
- ③ 产品形态编码: F-Male HSG (公HSG)
- ④ PIN数: 1xXX-1x01~2x12P
- ⑤ 材质: PT-PBT
- ⑥ 颜色: N-本色
- ⑦ 包装: B-袋装
- ⑧ 环保: R-ROHS
- ⑨ 流水码: 01
- ⑩ 特殊码: F-非汽车料号

Poles	Dimensions(mm)		Poles	Dimensions(mm)		Poles	Dimensions(mm)	
	A	B		A	B		A	B
02	5.00	1.50	07	12.30	9.00	12	19.80	16.50
03	6.30	3.00	08	13.80	10.50	13	21.30	18.00
04	7.80	4.50	09	15.30	12.00	14	22.80	19.50
05	9.30	6.00	10	16.80	13.50	15	24.30	21.00
06	10.80	7.50	11	18.30	15.00	16	25.80	22.50

日期	版次	变更编号	变更内容说明	变更人	核准
1					
2					
3					

东莞市翰皓精密电子有限公司  
Dongguan HanHao Precision Electronics Co., Ltd.

核准 审查 制作 日期  
JohnYang 20190816

料号: J1504HF-lx04  
名称: 1.5mm Pitch HSG 公单排

单位	比例	页次	版本	供应商编号
mm	2.5:1	1/1	A	XXXX

一般公差

X ±0.15  
XX ±0.05  
XXX ±0.03  
X.\* ±0.2\*

视角

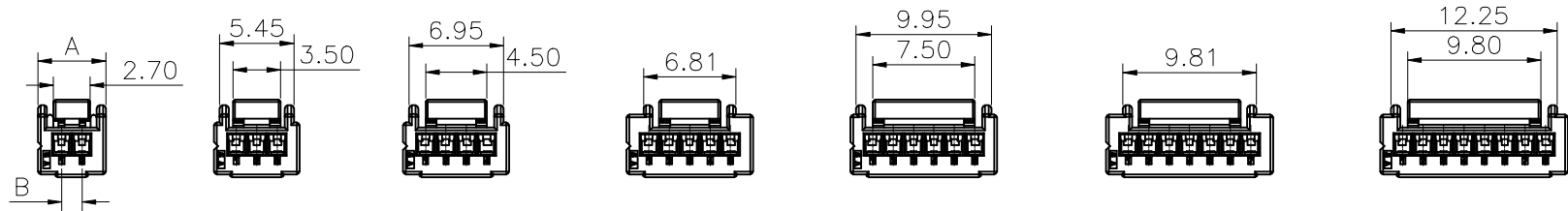

2PIN      3PIN      4PIN      5PIN      6PIN      7PIN      8PIN

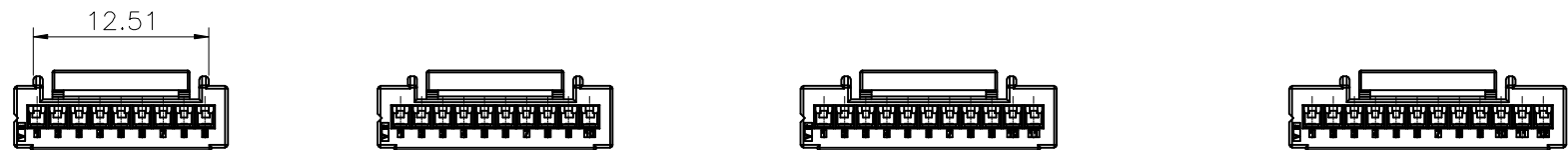

9PIN      10PIN      11PIN      12PIN

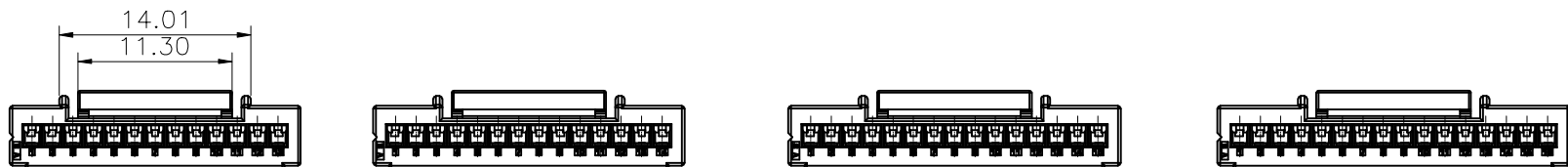

13PIN      14PIN      15PIN      16PIN

Poles	Dimensions(mm)		Poles	Dimensions(mm)		Poles	Dimensions(mm)	
	A	B		A	B		A	B
02	5.00	1.50	07	12.30	9.00	12	19.80	16.50
03	6.30	3.00	08	13.80	10.50	13	21.30	18.00
04	7.80	4.50	09	15.30	12.00	14	22.80	19.50
05	9.30	6.00	10	16.80	13.50	15	24.30	21.00
06	10.80	7.50	11	18.30	15.00	16	25.80	22.50

					一般公差	<b>东莞市翰皓精密电子有限公司</b>				料号: J1504HF-bXX					
					X ±0.15	<b>Dongguan HanHao Precision Electronics Co.,Ltd</b>				名称: 1.5mm Pitch HSG 公单排					
					JXX ±0.10	核准	审查	制作	日期						
					J0XX ±0.08										
					X* ±0.2°										
					视角										
日期	版次	变更编号	变更内容说明	变更人	核准	JohnYang				20190818	单位	比例	页次	版本	供应商编号
mm	2.5:1	1/1	A						XXXX						

RoHS

本产品符合我司QA-3-04-005  
环境管理物质标准规范

零件工程图

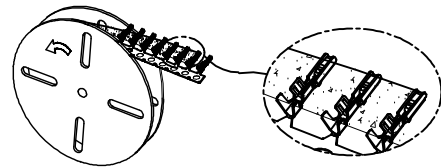

电镀后收料方向

比例 4:1

Specifications :

- Voltage rating: 125V AC / DC
- Current rating: 2A AC / DC
- Withstanding voltage: 500V AC/minute
- Temperature range: -40°C~+105°C
- Insulation resistance: ≥500MΩ
- Contact resistance: ≤20mΩ
- After environmental testing: ≤40mΩ

NOTES:

- Part No.: M1504T
- Applicable Wire: AWG#24-28
- Material: Phosphor Bronze THICKNESS:0.15 ±0.01MM
- Qty: 10,000 Pcs/Reel

J1504 T F-P XX S X 01 F

① ② ③ ④ ⑤ ⑥ ⑦ ⑧ ⑨

① 系列

② 类别: T-端子

③ 外观形态: F-公端

④ 材质: P-磷铜C5191R-H

⑤ 电镀类别:

37-半金锡3u;

41镀镍底亮锡 (N150u~100u" Sn100~200u")

42镀镍底雾锡 (N150u~100u" Sn100~200u")

⑥ 电镀方式: S-先冲后镀

⑦ 高低脚:H-高脚; L-低脚;

高低脚	Dimensions (mm)			
	A	B	C	D
⑧ H-高脚	1.85	1.45	1.95	1.40
⑨ H-低脚	1.40	0.65	1.65	1.00

流水码: 01

车用与非车用编码: F-非汽车料号

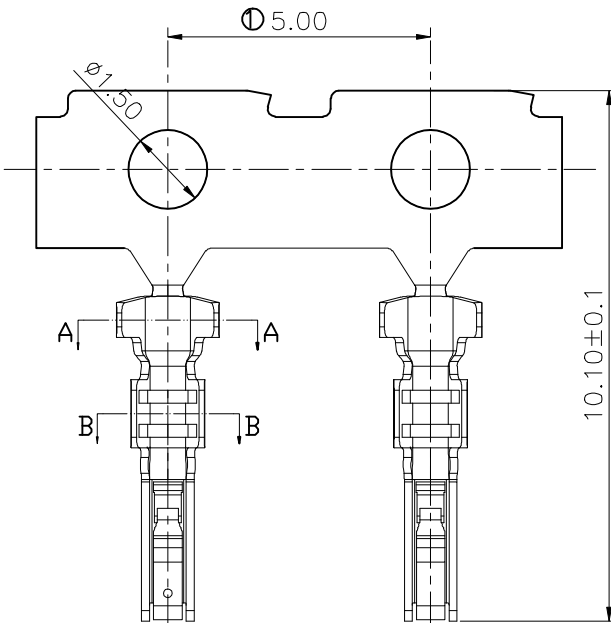

T=0.15±0.01

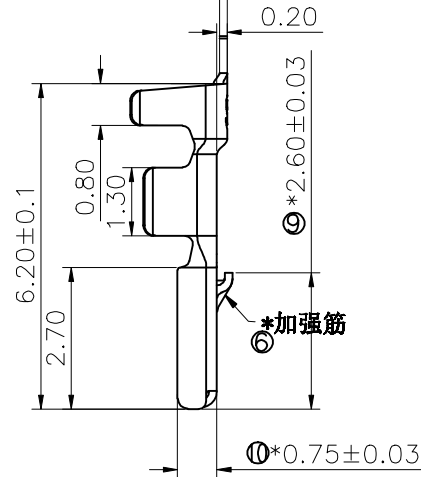

剖视图 C-C

比例 1:1

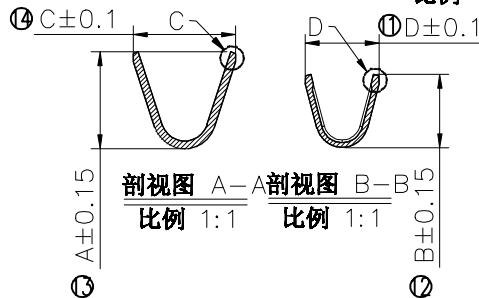

剖视图 A-A  
比例 1:1

剖视图 B-B  
比例 1:1

A

日期	版次	变更编号	变更内容说明	变更人	核准	一般公差
1						X ±0.15
						JXX ±0.05
						JJXX ±0.03
						X* ±0.2*
						视角

东莞市翰皓精密电子有限公司  
Dongguan HanHao Precision Electronics Co.,Ltd

料号: J1504TF

名称: 1.5mm Pitch 公端子

核准	审查	制作	日期
		JohnYang	20190816

单位	比例	页次	版本	供应商编号
mm	5:1	X/X	A	XXXX

1 2 3 4 5 6 7 8

RoHS

本产品符合我司QA-3-04-005  
环境管理物质标准规范

成品工程图

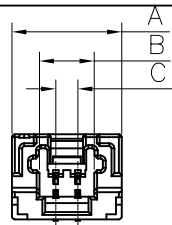

2PIN

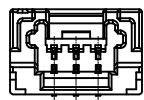

3PIN

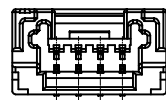

4PIN

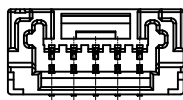

5PIN

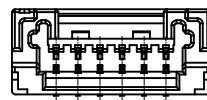

6PIN

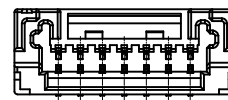

7PIN

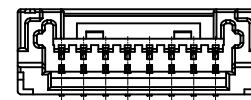

8PIN

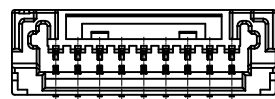

9PIN

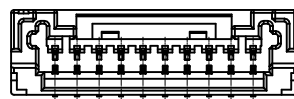

10PIN

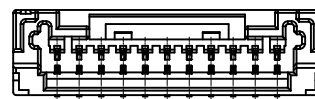

11PIN

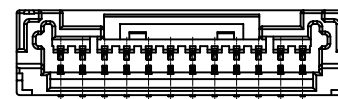

12PIN

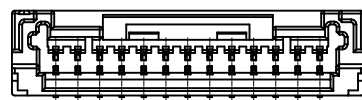

13PIN

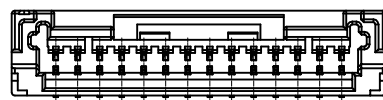

14PIN

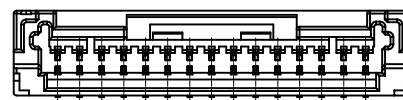

15PIN

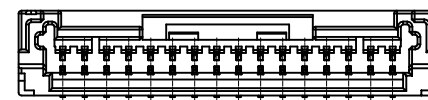

16PIN

Poles	Dimensions(mm)			Poles	Dimensions(mm)			Poles	Dimensions(mm)		
	A	B	C		A	B	C		A	B	C
02	7.50	3.75	1.50	07	15.00	11.25	9.00	12	22.50	18.75	16.50
03	9.00	5.25	3.00	08	16.50	12.75	10.50	13	24.00	20.25	18.00
04	10.50	6.75	4.50	09	18.00	14.25	12.00	14	25.50	21.75	19.50
05	12.00	8.25	6.00	10	19.50	15.75	13.50	15	27.00	23.25	21.00
06	13.50	9.75	7.50	11	21.00	17.25	15.00	16	28.50	24.75	22.50

	D						
	C						
	B						
日期	版次	变更编号	变更内容说明	变更人	核准		

一般公差
X ±0.20
.XX ±0.15
.XXX ±0.08
X.° ±0.2°
视角

**东莞市翰皓精密电子有限公司**  
Dongguan HanHao Precision Electronics Co.,Ltd

核准	审查	制作	日期
		JohnYang	20190816

料号: J1504WRS-bXX				
名称: 1.5mm Pitch Connectors(90°)				
单位	比例	页次	版本	供应商编号
mm	1:1	X/X	A	XXXX

RoHS

本产品符合我司QA-3-04-005  
环境管理物质标准规范

成品工程图

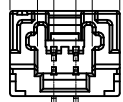
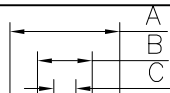

2PIN

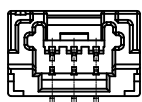

3PIN

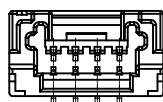

4PIN

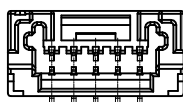

5PIN

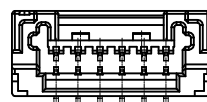

6PIN

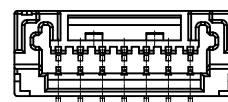

7PIN

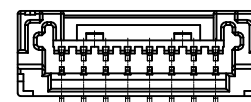

8PIN

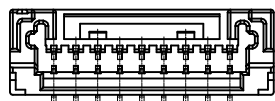

9PIN

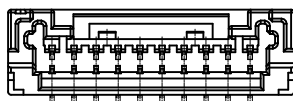

10PIN

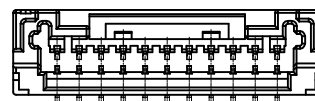

11PIN

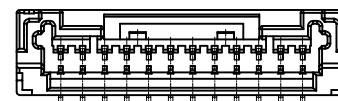

12PIN

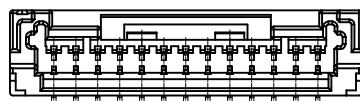

13PIN

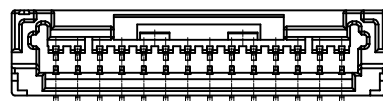

14PIN

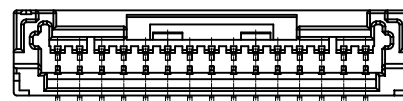

15PIN

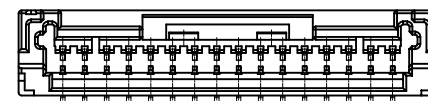

16PIN

Poles	Dimensions(mm)			Poles	Dimensions(mm)			Poles	Dimensions(mm)		
	A	B	C		A	B	C		A	B	C
02	7.50	3.75	1.50	07	15.00	11.25	9.00	12	22.50	18.75	16.50
03	9.00	5.25	3.00	08	16.50	12.75	10.50	13	24.00	20.25	18.00
04	10.50	6.75	4.50	09	18.00	14.25	12.00	14	25.50	21.75	19.50
05	12.00	8.25	6.00	10	19.50	15.75	13.50	15	27.00	23.25	21.00
06	13.50	9.75	7.50	11	21.00	17.25	15.00	16	28.50	24.75	22.50

	D								
	C								
	B								
日期	版次	变更编号	变更内容说明	变更人	核准				

一般公差
.X ±0.20
.XX ±0.15
.XXX ±0.08
X.° ±0.2°
视角

**东莞市翰皓精密电子有限公司**  
Dongguan HanHao Precision Electronics Co.,Ltd

核准	审查	制作	日期
		JohnYang	20190816

料号: J1504WVS-tXXX				
名称: 1.5mm Pitch Connectors(180°)				
单位	比例	页次	版本	供应商编号
mm	1:1	X/X	A	XXXX