

环保物料

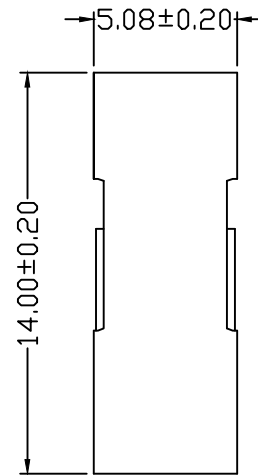
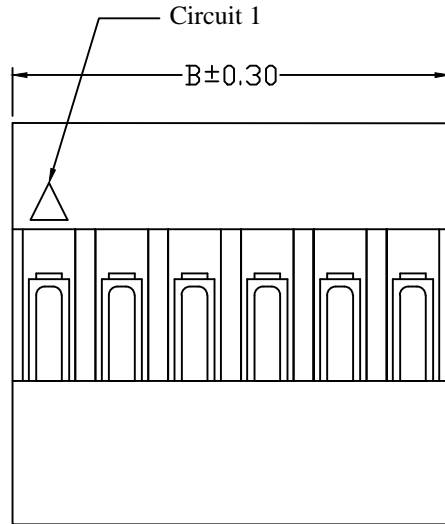
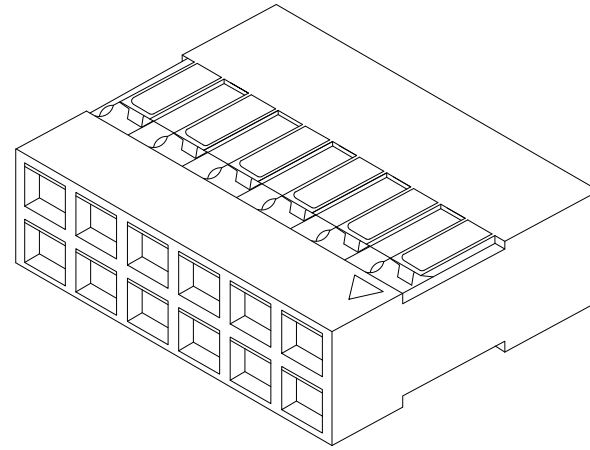
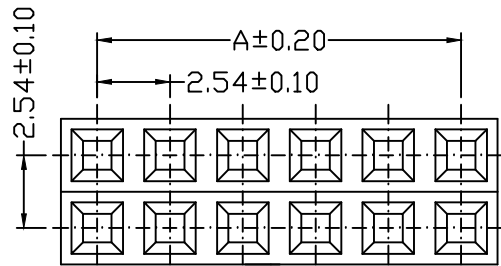

■ Specifications(规格) :

- Voltage rating(额定电压): 250V AC / DC
- Current rating(额定电流): 3A AC / DC
- Withstanding voltage(耐压值): 1500V AC/minute
- Temperature range(工作温度): -25°C~+85°C
- Insulation resistance(绝缘电阻): ≥1000MΩ
- Contact resistance(接触电阻): ≤20mΩ
- After environmental testing(环境测试后): ≤30mΩ

■ Housing(胶壳)

- Part No. (料号) :D2544H-2*XXP
- Poles (PIN数) : 04-80
- Material (材质) : PBT UL 94V-0
- Suitable HLB D2543T Series Terminal Or D2543FT Series Terminal (匹配D2543T系列端子或D2543FT端子)
- Mates With HLB PH2540、FH2540 Series Dual Row Wafer (匹配PH2540、FH2540双排系列针座)
- Q' ty (数量) : 1,000Pcs/Bag/每袋 (1,000Pcs)

Poles	PART NO.	Dimensions (mm)		Poles	PART NO.	Dimensions (mm)	
		A	B			A	B
04	D2544H-2*2P	2.54	5.08	44	D2544H-2*22P	53.34	55.88
06	D2544H-2*3P	5.08	7.62	46	D2544H-2*23P	55.88	58.42
08	D2544H-2*04P	7.62	10.16	48	D2544H-2*24P	58.42	60.96
10	D2544H-2*05P	10.16	12.70	50	D2544H-2*25P	60.96	63.50
12	D2544H-2*06P	12.70	15.24	52	D2544H-2*26P	63.50	66.04
14	D2544H-2*07P	15.24	17.78	54	D2544H-2*27P	66.04	68.58
16	D2544H-2*08P	17.78	20.32	56	D2544H-2*28P	68.58	71.12
18	D2544H-2*09P	20.32	22.86	58	D2544H-2*29P	71.12	73.66
20	D2544H-2*10P	22.86	25.40	60	D2544H-2*30P	73.66	76.20
22	D2544H-2*11P	25.40	27.94	62	D2544H-2*31P	76.20	78.74
24	D2544H-2*12P	27.94	30.48	64	D2544H-2*32P	78.74	81.28
26	D2544H-2*13P	30.48	33.02	66	D2544H-2*33P	81.28	83.82
28	D2544H-2*14P	33.02	35.56	68	D2544H-2*34P	83.82	86.36
30	D2544H-2*15P	35.56	38.10	70	D2544H-2*35P	86.36	88.90
32	D2544H-2*16P	38.10	40.64	72	D2544H-2*36P	88.90	91.44
34	D2544H-2*17P	40.64	43.18	74	D2544H-2*37P	91.44	93.98
36	D2544H-2*18P	43.18	45.72	76	D2544H-2*38P	93.98	96.52
38	D2544H-2*19P	45.72	48.26	78	D2544H-2*39P	96.52	99.06
40	D2544H-2*20P	48.26	50.80	80	D2544H-2*40P	99.06	101.60
42	6501H00-2*21P	50.80	53.34				

				一般公差 GENERAL TOLERANCE				东莞市翰皓精密电子有限公司 Dongguan HanHao Precision Electronics Co.,Ltd				料号 PART NO D2544H-2*XXP			
				.X ±0.3 .XX ±0.2 .XXX ±0.1				核准 APPD 审核 CHK 绘图 DR 日期 DATA				品名 TITLE 2.54 mm Crimp Style connectors			
2011/05/14	A	B	修改图框格式				DONG SUCCESS				单位 UNIT 比例 SCALE 图号 NUMBER 版次 REV MM 4/1 A-106 B				
日期 DATE	旧版次 OLD REV	新版次 NEW REV	变更内容 DESCRIPTION				角法 PROJECT				2007/05/03				

环保物料

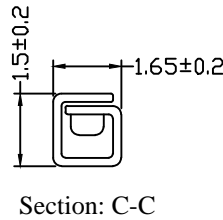
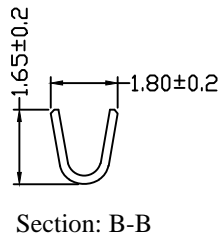
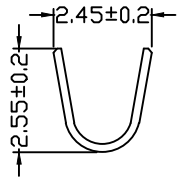
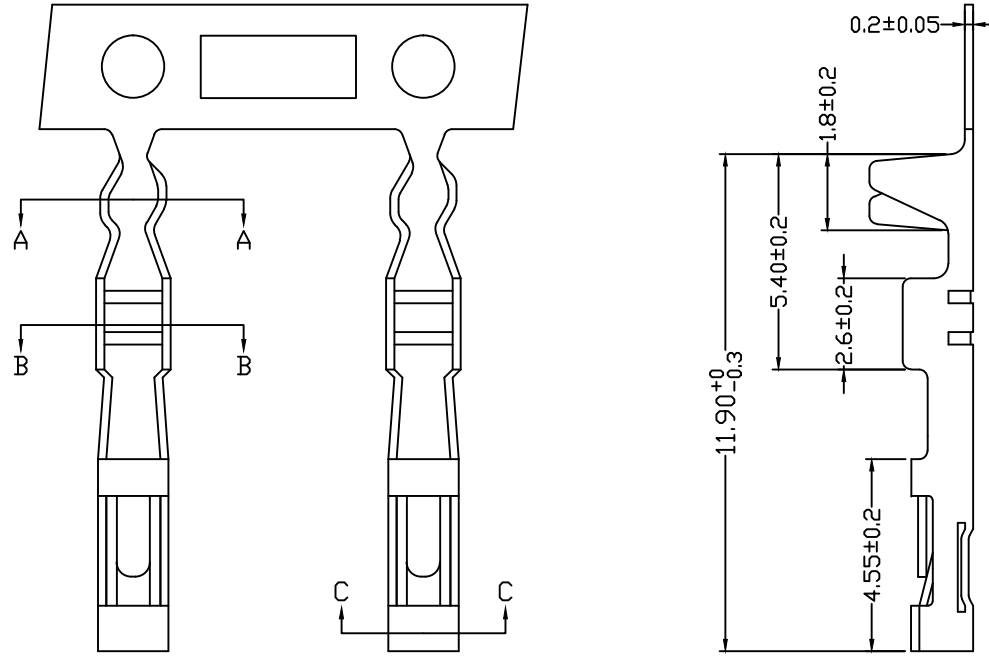

Specifications

- Voltage Rating: 250V AC/DC
- Current Rating: 3A AC/DC
- Withstanding Voltage: 1500V AC/Minute
- Insulation Resistance: 1000MΩ Min
- Temperature Range: -25°C~+85°C
- Contact resistance: Intial value/20mΩ Max
- After enviornmental testing/20mΩ Max

Terminal

- Part No.: D2543T
- Applicable Wire: AWG#28-32
- Material: Brass
- Finish: Gold-flash
- Q'ty: 10000 pcs/reel

							一般公差 GENERAL TOLERANCE				东莞市翰皓精密电子有限公司 Dongguan HanHao Precision Electronics Co.,Ltd				料号 PART NO D2543T			
							.X ±0.3 .XX ±0.2 .XXX ±0.1				核准 APPD				品名 TITLE 2.54 mm Crimp Style connectors			
2011/05/14							A B				修改图框格式				审核 CHK			
日期 DATE							旧版次 OLD REV				新版次 NEW REV				变更内容 DESCRIPTION			
							审核 CHK				核准 APPD				角法 PROJECT			
							1				SUCCESS				2007/05/03			
							单位 UNIT				比例 SCALE				图号 NUMBER			
							MM				4/1				A-093			
															版次 REV			
															B			

环保物料

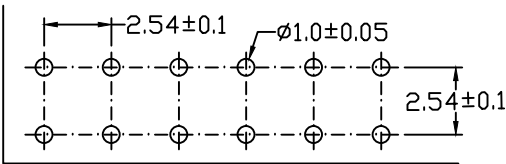
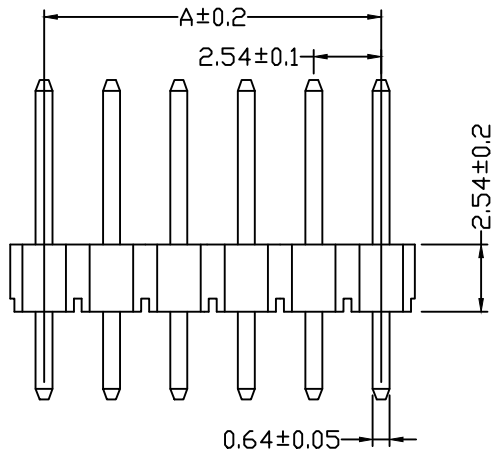
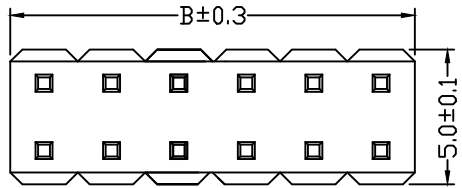

Recommend PCB Layout

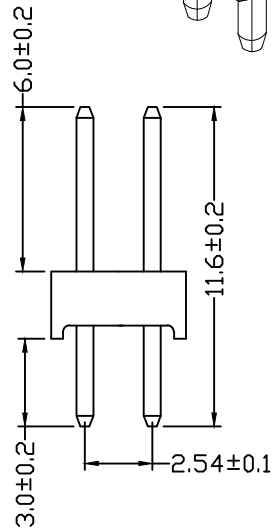
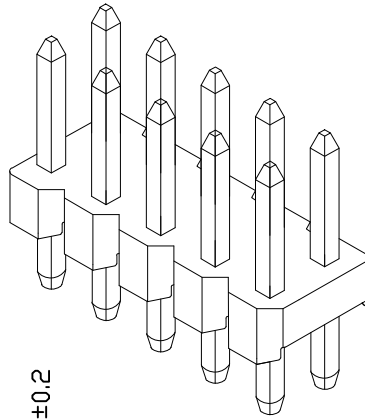

■ Specifications(规格) :

- Voltage rating(额定电压): 250V AC ,350V DC
- Current rating(额定电流): 3A AC / DC
- Withstanding voltage(耐压值): 1000V AC/minute
- Temperature range(工作温度): -25°C~+85°C
- Insulation resistance(绝缘电阻): ≥1000MΩ
- Contact resistance(接触电阻): ≤10mΩ
- After environmental testing(环境测试后): ≤20mΩ

■ Wafer(针座)

- Part No. (料号) : D2542W-2*XXP
- Poles (PIN数) : 04-80
- Material (材质) :Housing(胶壳) :PBT UL 94V-0
Pin针:Brass (黄铜)
Finish (电镀) :Gold-Plated (镀金)
- Q' ty (数量) : 1,000Pcs/Bag/每袋 (1,000Pcs)

Poles	PART NO.	Dimensions (mm)		Poles	PART NO.	Dimensions (mm)	
		A	B			A	B
04	D2542W-2*02P	2.54	5.08	44	D2542W-2*22P	53.34	55.88
06	D2542W-2*03P	5.08	7.62	46	D2542W-2*23P	55.88	58.42
08	D2542W-2*04P	7.62	10.16	48	D2542W-2*24P	58.42	60.96
10	D2542W-2*05P	10.16	12.70	50	D2542W-2*25P	60.96	63.50
12	D2542W-2*06P	12.70	15.24	52	D2542W-2*26P	63.50	66.04
14	D2542W-2*07P	15.24	17.78	54	D2542W-2*27P	66.04	68.58
16	D2542W-2*08P	17.78	20.32	56	D2542W-2*28P	68.58	71.12
18	D2542W-2*09P	20.32	22.86	58	D2542W-2*29P	71.12	73.66
20	D2542W-2*10P	22.86	25.40	60	D2542W-2*30P	73.66	76.20
22	D2542W-2*11P	25.40	27.94	62	D2542W-2*31P	76.20	78.74
24	D2542W-2*12P	27.94	30.48	64	D2542W-2*32P	78.74	81.28
26	D2542W-2*13P	30.48	33.02	66	D2542W-2*33P	81.28	83.82
28	D2542W-2*14P	33.02	35.56	68	D2542W-2*34P	83.82	86.36
30	D2542W-2*15P	35.56	38.10	70	D2542W-2*35P	86.36	88.90
32	D2542W-2*16P	38.10	40.64	72	D2542W-2*36P	88.90	91.44
34	D2542W-2*17P	40.64	43.18	74	D2542W-2*37P	91.44	93.98
36	D2542W-2*18P	43.18	45.72	76	D2542W-2*38P	93.98	96.52
38	D2542W-2*19P	45.72	48.26	78	D2542W-2*39P	96.52	99.06
40	D2542W-2*20P	48.26	50.80	80	D2542W-2*40P	99.06	101.60
42	D2542W-2*21P	50.80	53.34				

				一般公差 GENERAL TOLERANCE		东莞市翰皓精密电子有限公司 Dongguan Han Hao Precision Electronic Co.,Ltd.				料号 PART NO D2542W-2*XXP			
				. X ±0.3 . XX ±0.2 . XXX ±0.1		核准 APPD 审核 CHK 绘图 DR 日期 DATA				品名 TITLE 2.54 mm Crimp Style connectors			
2011/05/14	A	B	修改图框格式			SUCCESS				单位 UNIT 比例 SCALE 图号 NUMBER 版次 REV MM 1/1 A-106 B			
日期 DATE	旧版次 OLD REV	新版次 NEW REV	变更内容 DESCRIPTION			审核 CHK	核准 APPD	角法 PROJECT		2007/05/03			

环保物料

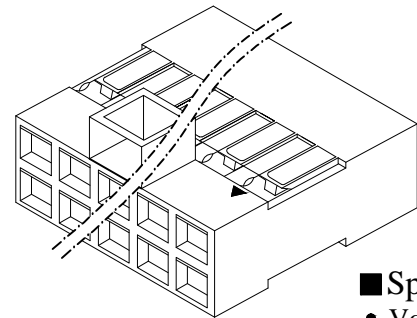
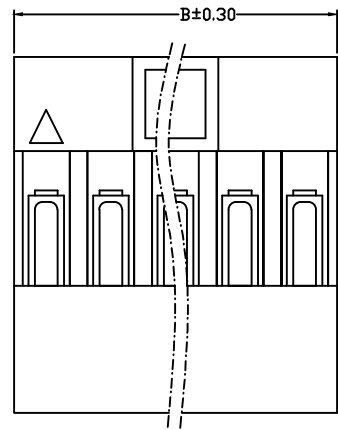
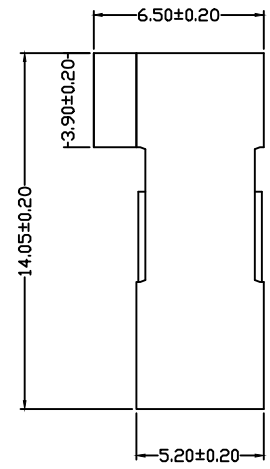
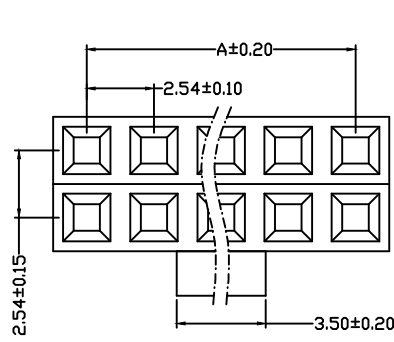

Poles	Part No	Dimensions (mm)	
		A	B
4	D2544HA-2*02	2.54	5.08
6	D2544HA-2*03	5.08	7.62
8	D2544HA-2*04	7.62	10.16
10	D2544HA-2*05	10.16	12.70
12	D2544HA-2*06	12.70	15.24
14	D2544HA-2*07	15.24	17.78
16	D2544HA-2*08	17.78	20.32
18	D2544HA-2*09	20.32	22.86
20	D2544HA-2*10	22.86	25.40
22	D2544HA-2*11	25.40	27.94
24	D2544HA-2*12	27.94	30.48
26	D2544HA-2*13	30.48	33.02
28	D2544HA-2*14	33.02	35.56
30	D2544HA-2*15	35.56	38.10
32	D2544HA-2*16	38.10	40.64
34	D2544HA-2*17	40.64	43.18
36	D2544HA-2*18	43.18	45.72
38	D2544HA-2*19	45.72	48.26
40	D2544HA-2*20	48.26	50.80

■ Specifications

- Voltage rating: 250V AC/DC
- Current rating: 3A AC/DC
- Withstanding Voltage: 1500V AC/Minute.
- Insulation resistance: 1000MΩ Min.
- Temperature range: -25°C~+85°C
- Contact resistance: Intial value/20mΩ Max.
- After enviornment testing/20mΩ Max.

■ Housing

- Part No.:D2544HA-2*XX
- Poles:4-40
- Material:PBT UL94V-0
- Q'ty:1,000 Pcs/Bag

				一般公差 GENERAL TOLERANCE				东莞市翰皓精密电子有限公司 Dongguan HanHao Precision Electronics Co.,Ltd				料号 PART NO D2544HA-2*XX													
				.X ±0.3 .XX ±0.2 .XXX ±0.1				核准 APPD		审核 CHK		绘图 DR		日期 DATA		品名 TITLE 2.54 mm Crimp Style connectors									
2011/05/14		A	B	修改图框格式																					
日期 DATE		旧版次 OLD REV	新版次 NEW REV	变更内容 DESCRIPTION				审核 CHK		核准 APPD		角法 PROJECT		1		SUCCESS				2007/05/03		单位 UNIT MM	比例 SCALE 4/1	图号 NUMBER A-093	版次 REV B

环保物料

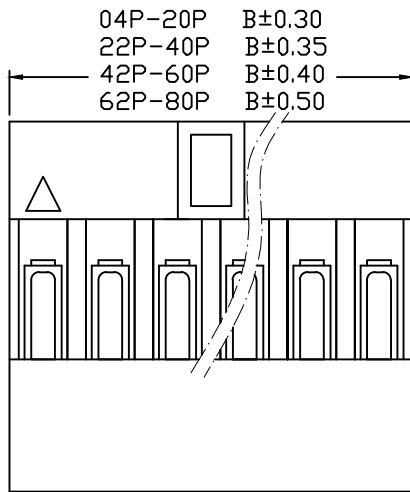
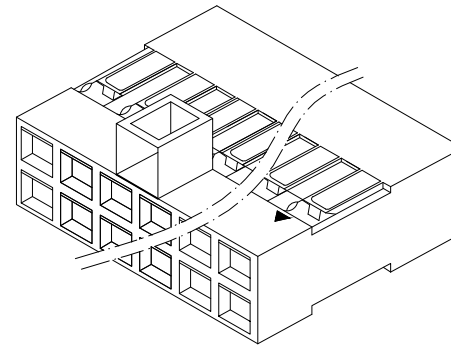
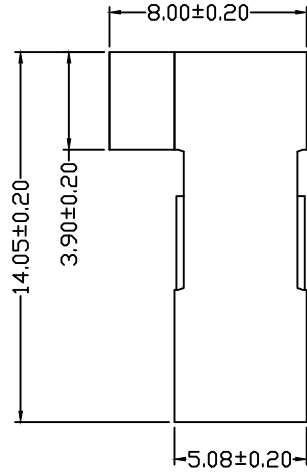
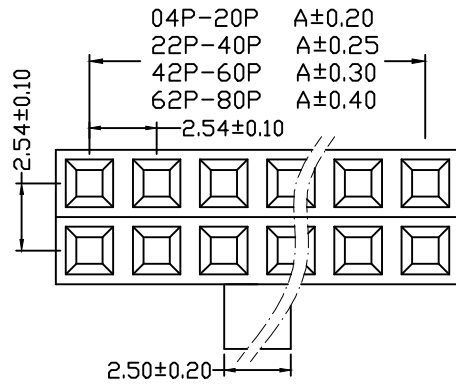

■ Specifications

- Voltage rating: 250V AC/DC
- Current rating: 3A AC/DC
- Withstanding Voltage: 1500V AC/Minute.
- Insulation resistance: 1000MΩ Min.
- Temperature range: -25°C~+85°C
- Contact resistance: Intial value/20mΩ Max.
- After enviornmental testing/20mΩ Max.

■ Housing

- Part No.: D2544HB-2*XX
- Poles: 04-80
- Material: PBT UL94V-0
- Suitable HLB D2544T series Terminal
- Mates with HLB FH2540 series dual row Pin Header
- Q'ty: 1000 pcs/bag

Poles	PART NO.	Dimensions (mm)	
		A	B
04	D2544HB-2*02	2.54	5.08
06	D2544HB-2*03	5.08	7.62
08	D2544HB-2*04	7.62	10.16
10	D2544HB-2*05	10.16	12.70
12	D2544HB-2*06	12.70	15.24
14	D2544HB-2*07	15.24	17.78
16	D2544HB-2*08	17.78	20.32
18	D2544HB-2*09	20.32	22.86
20	D2544HB-2*10	22.86	25.40
22	D2544HB-2*11	25.40	27.94
24	D2544HB-2*12	27.94	30.48
26	D2544HB-2*13	30.48	33.02
28	D2544HB-2*14	33.02	35.56
30	D2544HB-2*15	35.56	38.10
32	D2544HB-2*16	38.10	40.64
34	D2544HB-2*17	40.64	43.18
36	D2544HB-2*18	43.18	45.72
38	D2544HB-2*19	45.72	48.26
40	D2544HB-2*20	48.26	50.80
42	D2544HB-2*21	50.80	53.34

	PART NO.	Dimensions (mm)	
		A	B
44	D2544HB-2*22	53.34	55.88
46	D2544HB-2*23	55.88	58.42
48	D2544HB-2*24	58.42	60.96
50	D2544HB-2*25	60.96	63.50
52	D2544HB-2*26	63.50	66.04
54	D2544HB-2*27	66.04	68.58
56	D2544HB-2*28	68.58	71.12
58	D2544HB-2*29	71.12	73.66
60	D2544HB-2*30	73.66	76.20
62	D2544HB-2*31	76.20	78.74
64	D2544HB-2*32	78.74	81.28
66	D2544HB-2*33	81.28	83.82
68	D2544HB-2*34	83.82	86.36
70	D2544HB-2*35	86.36	88.90
72	D2544HB-2*36	88.90	91.44
74	D2544HB-2*37	91.44	93.98
76	D2544HB-2*38	93.98	96.52
78	D2544HB-2*39	96.52	99.06
80	D2544HB-2*40	99.06	101.60

				一般公差 GENERAL TOLERANCE				东莞市翰皓精密电子有限公司 Dongguan HanHao Precision Electronics Co.,Ltd				料号 PART NO D2544HB-2*XX			
				.X ±0.3 .XX ±0.2 .XXX ±0.1				核准 APPD 审核 CHK 绘图 DR 日期 DATA				品名 TITLE 2.54 mm Crimp Style connectors			
2011/05/14	A	B	修改图框格式				1				SUCCESS				
日期 DATE	旧版次 OLD REV	新版次 NEW REV	变更内容 DESCRIPTION				角法 PROJECT				单位 UNIT 比例 SCALE 图号 NUMBER 版次 REV				
							⊕ □				MM 4/1 A-093 B				

环保物料

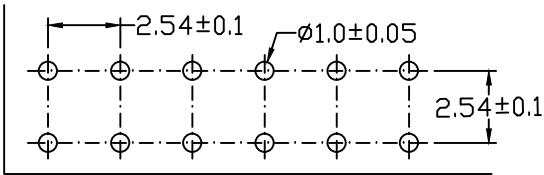
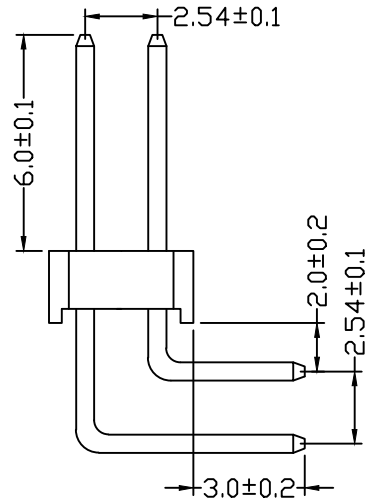
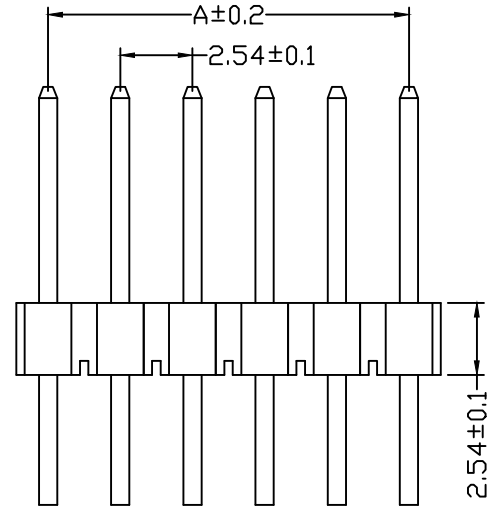
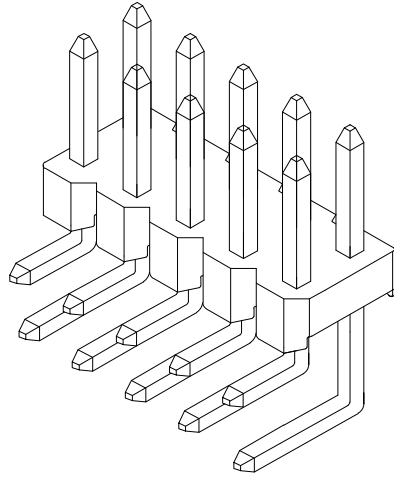
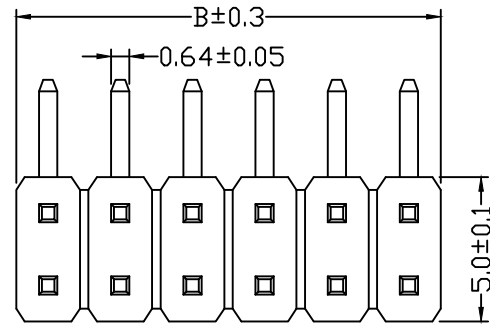

Recommad PCB Layout

■ Specifications(规格) :

- Voltage rating(额定电压): 250V AC ,350V DC
- Current rating(额定电流): 3A AC / DC
- Withstanding voltage(耐压值): 1500V AC/minute
- Temperature range(工作温度): -25°C~+85°C
- Insulation resistance(绝缘电阻): ≥1000MΩ
- Contact resistance(接触电阻): ≤20mΩ
- After environmental testing(环境测试后): ≤30mΩ

■ Wafer(针座)

- Part No. (料号) : D2547WR-2*XXP
- Poles (PIN数) : 04-80
- Material (材质) :Housing(胶壳) :PBT UL 94V-0
Pin针:Brass (黄铜)
Finish (电镀) :Gold-Plated (镀金)
- Mates With HLB D2542H Series Dual Row Housing (匹配D2542双排系列胶壳)
- Q' ty (数量) : 1,000Pcs/Bag/每袋 (1,000Pcs)

Poles	PART NO.	Dimensions (mm)		Poles	PART NO.	Dimensions (mm)	
		A	B			A	B
04	D2547WR-2*02P	2.54	5.08	44	D2547WR-2*22P	53.34	55.88
06	D2547WR-2*03P	5.08	7.62	46	D2547WR-2*23P	55.88	58.42
08	D2547WR-2*04P	7.62	10.16	48	D2547WR-2*24P	58.42	60.96
10	D2547WR-2*05P	10.16	12.70	50	D2547WR-2*25P	60.96	63.50
12	D2547WR-2*06P	12.70	15.24	52	D2547WR-2*26P	63.50	66.04
14	D2547WR-2*07P	15.24	17.78	54	D2547WR-2*27P	66.04	68.58
16	D2547WR-2*08P	17.78	20.32	56	D2547WR-2*28P	68.58	71.12
18	D2547WR-2*09P	20.32	22.86	58	D2547WR-2*29P	71.12	73.66
20	D2547WR-2*10P	22.86	25.40	60	D2547WR-2*30P	73.66	76.20
22	D2547WR-2*11P	25.40	27.94	62	D2547WR-2*31P	76.20	78.74
24	D2547WR-2*12P	27.94	30.48	64	D2547WR-2*32P	78.74	81.28
26	D2547WR-2*13P	30.48	33.02	66	D2547WR-2*33P	81.28	83.82
28	D2547WR-2*14P	33.02	35.56	68	D2547WR-2*34P	83.82	86.36
30	D2547WR-2*15P	35.56	38.10	70	D2547WR-2*35P	86.36	88.90
32	D2547WR-2*16P	38.10	40.64	72	D2547WR-2*36P	88.90	91.44
34	D2547WR-2*17P	40.64	43.18	74	D2547WR-2*37P	91.44	93.98
36	D2547WR-2*18P	43.18	45.72	76	D2547WR-2*38P	93.98	96.52
38	D2547WR-2*19P	45.72	48.26	78	D2547WR-2*39P	96.52	99.06
40	D2547WR-2*20P	48.26	50.80	80	D2547WR-2*40P	99.06	101.60
42	D2547WR-2*21P	50.80	53.34				

							一般公差 GENERAL TOLERANCE				东莞市翰皓精密电子有限公司 Dongguan HanHao Precision Electronics Co.,Ltd				料号 PART NO D2547WR-2*XXP				
							.X ±0.3 .XX ±0.2 .XXX ±0.1								品名 TITLE 2.54 mm Crimp Style connectors				
2011/05/14		A	B	修改图框格式							核准 APPD	审核 CHK	绘图 DR	日期 DATA		单位 UNIT	比例 SCALE	图号 NUMBER	版次 REV
日期 DATE		旧版次 OLD REV	新版次 NEW REV	变更内容 DESCRIPTION			审核 CHK	核准 APPD	角法 PROJECT		SUCCESS			2007/05/03		MM	1/1	A-106	B