

04P~20P Shape  
Scale 1:1

02P~03P Shape  
Scale 1:1

■ Specifications :

- Voltage rating: 125V AC / DC
- Current rating: 2A AC / DC
- Withstanding voltage: 1000V AC/minute
- Temperature range: -40°C~+105°C
- Insulation resistance: ≥1000MΩ
- Contact resistance: ≤20mΩ
- After environmental testing: ≤30mΩ
- Suitable HLB Terminal: M2007T
- Suitable HLB Wafer: M2007WV / M2007WR
- "★" Critical dimension

- ① Series No.
- ② Category: M2007H
- ③ Appearance type: Ordinary
- ④ Row No.-Pin No.: 02P~20P
- ⑤ Plug the Pin & Special No.: Ordinary
- ⑥ Material : PA66 UL 94V-0
- ⑦ Color : Natural Color

Poles	Dimensions (mm)			Poles	Dimensions (mm)		
	A	B	C		A	B	C
02	2.00	7.30	5.10	12	22.00	26.30	25.10
03	4.00	9.30	7.10	13	24.00	28.30	27.10
04	6.00	10.30	9.10	14	26.00	30.30	29.10
05	8.00	12.30	11.10	15	28.00	32.30	31.10
06	10.00	14.30	13.10	16	30.00	34.30	33.10
07	12.00	16.30	15.10	17	32.00	36.30	35.10
08	14.00	18.30	17.10	18	34.00	38.30	37.10
09	16.00	20.30	19.10	19	36.00	40.30	39.10
10	18.00	22.30	21.10	20	38.00	42.30	41.10
11	20.00	24.30	23.10				

				GENERAL TOLERANCE			东莞市翰皓精密电子有限公司 Dongguan HanHao Precision Electronics Co.,Ltd				PART NO. M2007H-XX			
				.X ±0.30			APPROVAL				TITLE 2.0 mm Crimp Style Connectors			
				.XX ±0.20			CHECK				UNIT			
				.XXX ±0.10			DRAWN				SCALE			
				PROJECT			DATA				NUMBER			
2018/3/02				A B			Smark				mm			
DATE				ECN			Yu wei				1:1			
OLD REV				DESCRIPTION			Liu Yan				8			
NEW REV				CHECK			2012/03/28				REV			
ECN				APPROVAL			B							
1				2			3				4			
5				6			7				8			

1 2 3 4 5 6 7 8

F  
E  
D  
C  
B

F  
E  
D  
C  
B

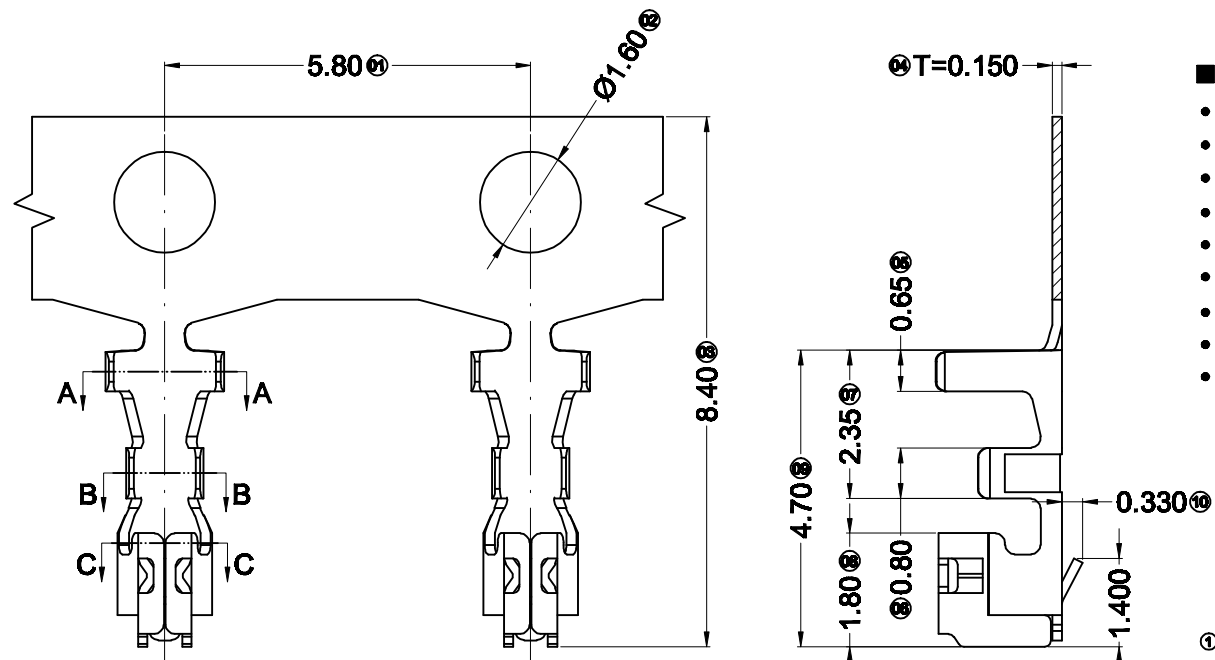

■ Specifications :

- Voltage rating: 125V AC / DC
- Current rating: 2A AC / DC
- Withstanding voltage: 1000V AC/minute
- Temperature range: -40°C~+105°C
- Insulation resistance: ≥1000MΩ
- Contact resistance: ≤20mΩ
- After environmental testing: ≤30mΩ
- Used In HLB Housing: M2007H
- "★" Critical dimension

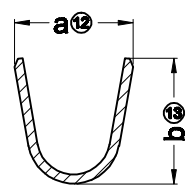

SECTION: A-A  
SCALE: 1:1

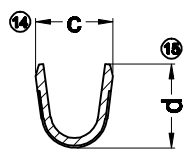

SECTION: B-B  
SCALE: 1:1

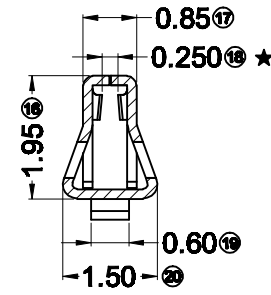

SECTION: C-C  
SCALE: 1:1

- ① Series Number
- ② Category: M2007T
- ③ Shape: ordinary ; High Crimp
- ④ Material: Phosphor bronze
- ⑤ Plating style: Bright tin plating
- ⑥ Plating method: Stamping before plating
- ⑦ Mold No./Mark/Special No. :

							<b>GENERAL TOLERANCE</b> X ±0.30 XX ±0.20 XXX ±0.10				<b>东莞市翰皓精密电子有限公司</b> Dongguan HanHao Precision Electronics Co.,Ltd				<b>PART NO.</b> M2007T				
											<b>TITLE</b> 2.0 mm Crimp Style Connectors								
2018/3/02	A	B		Modify frame format	Jova	Jova Lau	<b>APPROVAL</b> Smark		<b>CHECK</b> Yu wei		<b>DRAWN</b> Liu Yan		<b>DATA</b> 2012/03/28		UNIT mm	SCALE 1:1	NUMBER 8	REV B	
<b>DATE</b>	<b>OLD REV</b>	<b>NEW REV</b>	<b>ECN</b>	<b>DESCRIPTION</b>	<b>CHECK</b>	<b>APPROVAL</b>	<b>PROJECT</b>												

1 2 3 4 5 6 7 8

1 2 3 4 5 6 7 8

F  
E  
D  
C  
B  
A

F  
E  
D  
C  
B  
A

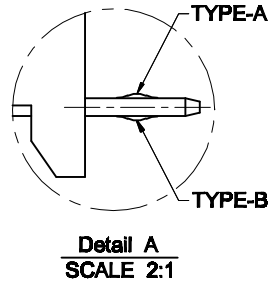
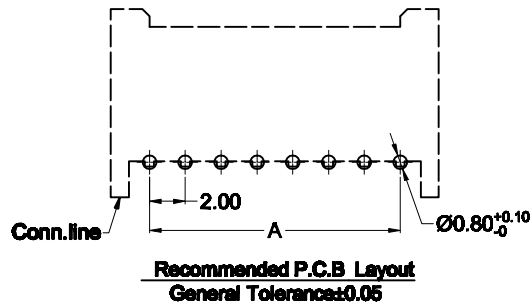
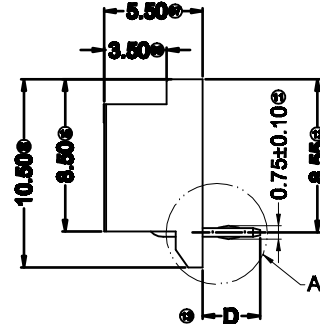
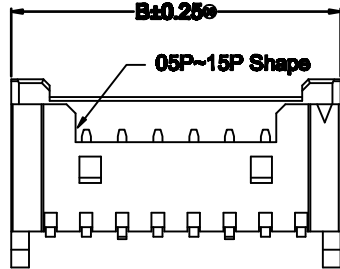
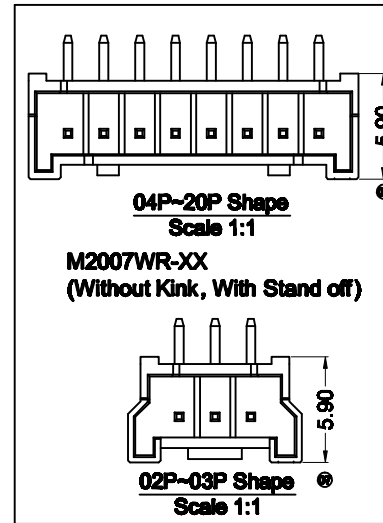
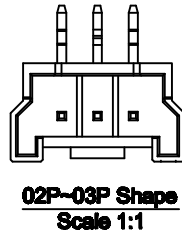
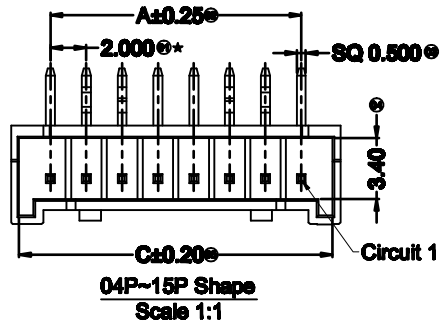

With Kink to Choose the type(A Or B)

Poles	TYPE	PIN No								
		1	2	3	4	5	6	N-2	N-1	N
6 PIN Over	-	A	B	-	-	-	-	B	A	-
5 PIN	A	B	-	B	A	-	-	-	-	-
4 PIN	A	B	B	A	-	-	-	-	-	-
3 PIN	A	B	A	-	-	-	-	-	-	-
2 PIN	A	B	-	-	-	-	-	-	-	-

- Specifications :
- Voltage rating: 125V AC / DC
  - Current rating: 2A AC / DC
  - Withstanding voltage: 1000V AC/minute
  - Temperature range: -40°C~+105°C
  - Insulation resistance: ≥1000MΩ
  - Contact resistance: ≤20mΩ
  - After environmental testing : ≤30mΩ
  - Mates With HLB Housing:M2007H
  - "\*" Critical dimension

- ① Series No.  
 ② Category : M2007WR  
 ③ Welding Board Angle: Right Angle 90°  
 ④ Welding Way: DIP  
 ⑤ Row No.-Pin No.: 02P~20P  
 ⑥ Plug the Pin & Special No.:  
 DIP=3.20mm,With Kink  
 DIP=2.50mm,With Kink  
 DIP=2.10mm,Without Kink  
 DIP=2.10mm,Without Kink, With Stand off  
 ⑦ Material: PA66 UL 94V-0  
 PAST UL 94V-0  
 ⑧ Plating Category: Bright Tin Plating  
 Matte Tin Plating  
 ⑨ Color : Natural Color

Dim"D"	
TYPE	Dimensions (mm)
A	3.20mm,With Kink
B	2.50mm,With Kink
C	2.10mm,Without Kink
C1	2.10mm,Without Kink, With Stand off

Poles	Dimensions (mm)			Poles	Dimensions (mm)		
	A	B	C		A	B	C
02	2.00	7.70	5.30	09	16.20	20.50	19.60
03	4.00	9.70	7.30	10	18.20	22.50	21.60
04	6.00	10.30	9.30	11	20.20	24.60	23.60
05	8.00	12.30	11.30	12	22.20	26.60	25.70
06	10.00	14.30	13.30	13	24.20	28.70	27.70
07	12.10	16.40	15.50	14	26.20	30.70	29.70
08	14.10	18.40	17.50	15	28.20	32.80	31.80

A								GENERAL TOLERANCE		东莞市翰皓精密电子有限公司				PART NO.							
								X ±0.30		Dongguan HanHao Precision Electronics Co.,Ltd				M2007WR-XX							
								XX ±0.20		APPROVAL		CHECK		DRAWN		DATA		TITLE			
								XXX ±0.10		Smark		Yu wei		Liu Yan		2012/03/28		2.0 mm Crimp Style Connectors			
DATE	OLD REV	NEW REV	ECN	DESCRIPTION	CHECK	APPROVAL	PROJECT	UNIT		SCALE		NUMBER		REV							
2018/3/02	A	B		Modify frame format	Jova	Jova Lau	⊕	mm		1:1		8		B							

1 2 3 4 5 6 7 8

1 | 2 | 3 | 4 | 5 | 6 | 7 | 8

F  
E  
D  
C  
B  
A

F  
E  
D  
C  
B  
A

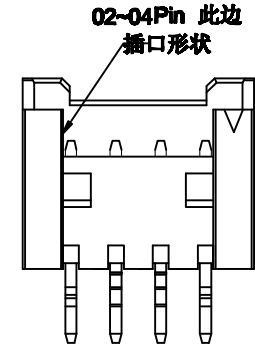
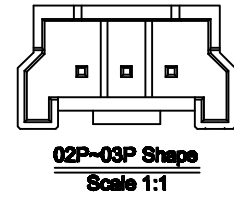
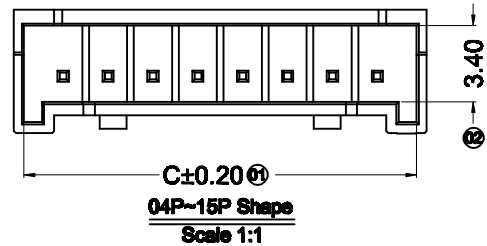

- Specifications :
- Voltage rating: 125V AC / DC
  - Current rating: 2A AC / DC
  - Withstanding voltage: 1000V AC/minute
  - Temperature range: -40°C~+105°C
  - Insulation resistance: ≥1000MΩ
  - Contact resistance: ≤20mΩ
  - After environmental testing : ≤30mΩ
  - Mates With HLB Housing : M2007H
  - "\*" Critical dimension

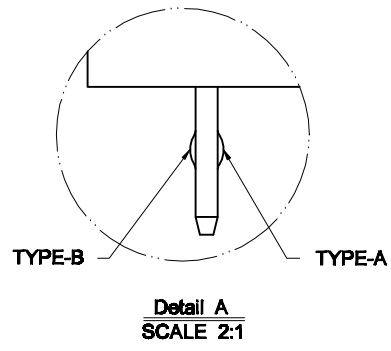
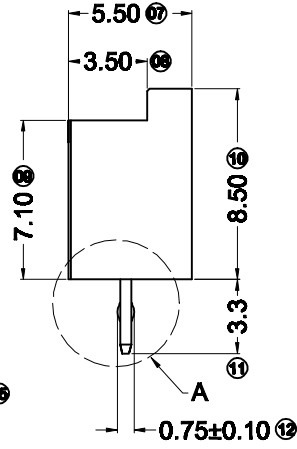
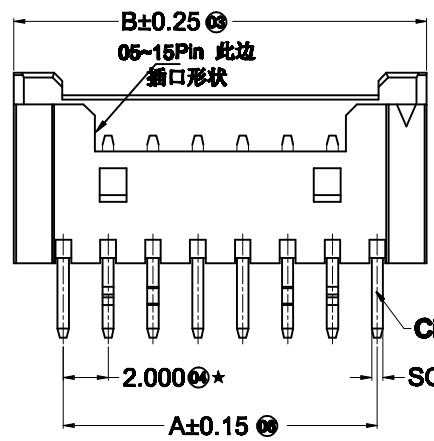

- ① Series No.
- ② Category: M2007WV
- ③ Welding Board Angle: Straight 180°
- ④ Welding Way: DIP
- ⑤ Row No.-Pin No.: 02P~20P
- ⑥ Plug the Pin & Special No.:
- ⑦ Material: PA66 UL 94V-0
- ⑧ Plating Category: Bright Tin Plating
- ⑨ Color: Natural Color

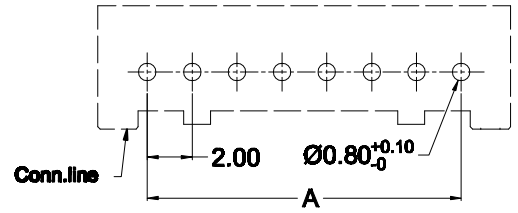

With K to Choose the type(A Or B)

Poles	PIN No	1	2	3	4	5	6	N-2	N-1	N
6 PIN Over	TYPE	-	A	B	-	-	-	B	A	-
6 PIN		-	A	B	B	A	-	-	-	-
5 PIN		A	B	-	B	A	-	-	-	-
4 PIN		A	B	B	A	-	-	-	-	-
3 PIN		A	B	A	-	-	-	-	-	-
2 PIN		A	B	-	-	-	-	-	-	-

Poles	Dimensions (mm)			Poles	Dimensions (mm)		
	A	B	C		A	B	C
02	2.00	7.70	5.30	09	16.20	20.50	19.00
03	4.00	9.70	7.30	10	18.20	22.50	21.00
04	6.00	10.30	9.30	11	20.20	24.60	23.00
05	8.00	12.30	11.30	12	22.20	26.60	25.70
06	10.00	14.30	13.30	13	24.20	28.70	27.70
07	12.10	16.40	15.50	14	26.20	30.70	29.70
08	14.10	18.40	17.50	15	28.30	32.80	31.00

							GENERAL TOLERANCE				东莞市翰皓精密电子有限公司 Dongguan Han-Hao Precision Electronics Co.,Ltd				PART NO. M2007WV-XX			
							X ±0.30				APPROVAL				TITLE 2.0 mm Crimp Style Connectors			
							XX ±0.20				CHECK				UNIT mm			
							JXX ±0.10				DRAWN				SCALE 1:1			
2018/3/02				A B			Modify frame format				Smark				NUMBER 8			
DATE				OLD REV NEW REV ECN			DESCRIPTION				Yu wei				REV B			
							Jova Jova Lau				Liu Yan							
											2012/03/28							

1 | 2 | 3 | 4 | 5 | 6 | 7 | 8