

1 2 3 4 5 6 7 8

F
E
D
C
B
A

F
E
D
C
B
A

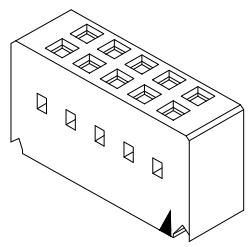
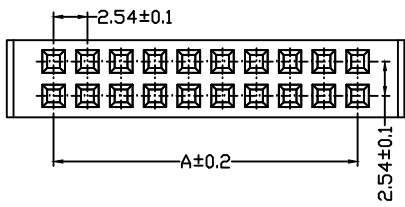

■ Specifications

- Voltage Rating: 250V AC/DC
- Current Rating: 3A AC/DC
- Withstanding Voltage: 1500V AC/minute
- Insulation Resistance: 1000MΩ min.
- Temperature Range: -25°C~+85°C
- Contact Resistance: Initial value/20mΩ max.
- After Environmental Testing/20mΩ max.

■ Housing

- Part No.: M2547H
- Material: PBT UL94V-0
- Suitable HLB M2547T Series Terminal
- Mates With HLB M2547W Series Wafer
- Q'ty: 1,000 Pcs/Bag

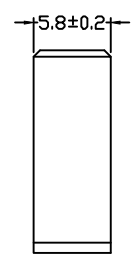
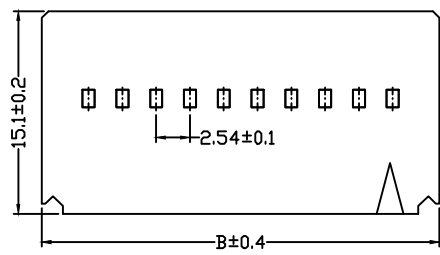

Poles	Part No	Dimensions (mm)	
		A	B
4	M2547H-04	2.54	9.54
6	M2547H-06	5.08	12.08
8	M2547H-08	7.62	14.62
10	M2547H-10	10.16	17.16
12	M2547H-12	12.70	19.70
14	M2547H-14	15.27	22.24
16	M2547H-16	17.78	24.78
18	M2547H-18	20.32	27.32
20	M2547H-20	22.86	29.86
22	M2547H-22	25.40	32.40
24	M2547H-24	27.94	34.94
26	M2547H-26	30.48	37.48
28	M2547H-28	33.02	40.02
30	M2547H-30	35.56	42.56
32	M2547H-32	38.10	45.10
34	M2547H-34	40.64	47.64
36	M2547H-36	43.18	50.18
38	M2547H-38	45.72	52.72
40	M2547H-40	48.26	55.26

							GENERAL TOLERANCE .X ±0.30 .XX ±0.20 .XXX ±0.10	东莞市翰皓精密电子有限公司 Dongguan HanHao Precision Electronics Co.,Ltd				PART NO. M2547H-2*XX			
								APPROVAL				TITLE 2.54 mm Crimp Style Connectors			
2010/06/22	A	B		Modify frame format	Jova	Jova Lau	PROJECT	Smak	Yu wei	Liu Yan	2010/06/22	UNIT mm	SCALE 1:	NUMBER 8	REV B
DATE	OLD REV	NEW REV	ECN	DESCRIPTION	CHECK	APPROVAL									

1 2 3 4 5 6 7 8

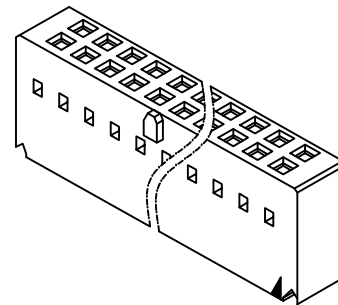
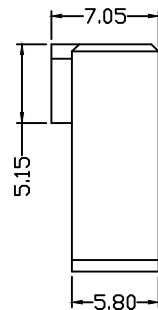
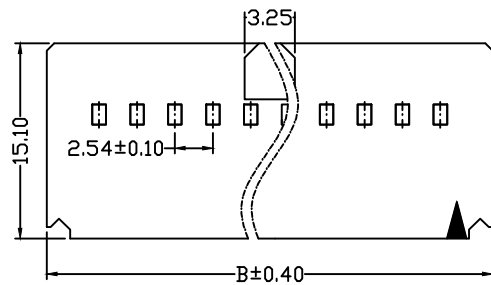
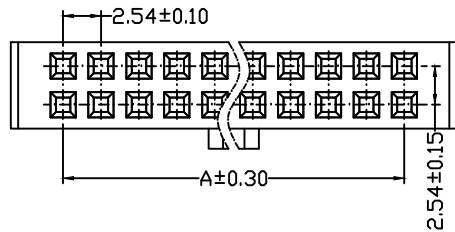

■ Specifications

- Voltage Rating: 250V AC / DC
- Current Rating: 3A AC / DC
- Withstanding Voltage: 1500V AC/minute
- Insulation Resistance: 1000MΩ Min.
- Temperature Range: -25°C~+85°C
- Contact Resistance: Initial value/20mΩ Max.
- After Environmental Testing/20mΩ Max.

■ Housing

- Part No.: M2547HA
- Material: PBT UL94V-0
- Suitable HLB M2547T Series Terminal
- Mates With HLB M2547W Series Wafer
- Q'ty: 1,000 Pcs/Bag

Poles	Part No	Dimensions (mm)	
		A	B
4	M2547HA-2*02	2.54	9.54
6	M2547HA-2*03	5.08	12.08
8	M2547HA-2*04	7.62	14.62
10	M2547HA-2*05	10.16	17.16
12	M2547HA-2*06	12.70	19.70
14	M2547HA-2*07	15.27	22.24
16	M2547HA-2*08	17.78	24.78
18	M2547HA-2*09	20.32	27.32
20	M2547HA-2*10	22.86	29.86
22	M2547HA-2*11	25.40	32.40
24	M2547HA-2*12	27.94	34.94
26	M2547HA-2*13	30.48	37.48
28	M2547HA-2*14	33.02	40.02
30	M2547HA-2*15	35.56	42.56
32	M2547HA-2*16	38.10	45.10
34	M2547HA-2*17	40.64	47.64
36	M2547HA-2*18	43.18	50.18
38	M2547HA-2*19	45.72	52.72
40	M2547HA-2*20	48.26	55.26

							GENERAL TOLERANCE		东莞市翰皓精密电子有限公司				PART NO. M2547HA-2*XX			
							.X ±0.30		Dongguan HanHao Precision Electronics Co.,Ltd				TITLE 2.54 mm Crimp Style Connectors			
							.XX ±0.20		APPROVAL		CHECK		DRAWN		DATA	
							.XXX ±0.10		Smark		Yu wei		Liu Yan		2010/06/22	
							PROJECT		UNIT mm		SCALE 1:		NUMBER 8		REV B	
2010/06/22	A	B		Modify frame format	Jova	Jova Lau	PROJECT		UNIT mm		SCALE 1:		NUMBER 8		REV B	
DATE	OLD REV	NEW REV	ECN	DESCRIPTION	CHECK	APPROVAL	PROJECT		UNIT mm		SCALE 1:		NUMBER 8		REV B	

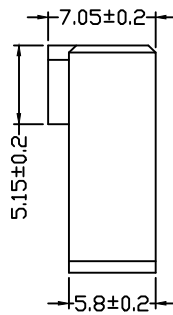
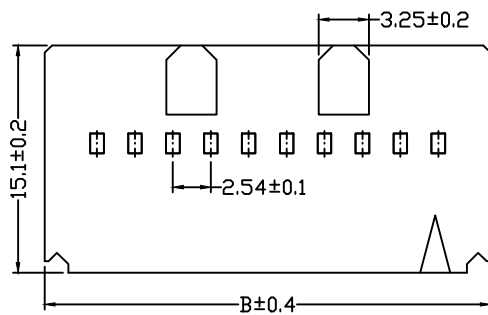
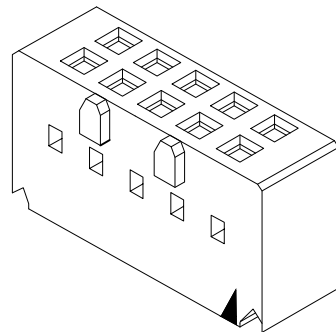
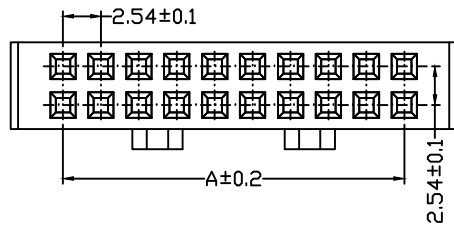

■ SPECIFICATIONS

- Voltage rating: 250V AC, DC
- Current rating: 3A, AC, DC
- Withstanding Voltage: 1500V AC/minute
- Insulation resistance: 1000MΩmin
- Temperature range: -25°C~+85°C
- Contact resistance: Initial value/20mΩmax
- After environmental testing/20mΩmax

■ HOUSING

- Part No.: M2547HB
- Material: PBT UL94V-0
- Suitable HLB M2547T series Terminal
- Mates with HLB M2547W series Wafer
- Q'ty: 1000 pcs/bag

Poles	Part No	Dimensions (mm)	
		A	B
4	M2547HB-04	2.54	9.54
6	M2547HB-06	5.08	12.08
8	M2547HB-08	7.62	14.62
10	M2547HB-10	10.16	17.16
12	M2547HB-12	12.70	19.70
14	M2547HB-14	15.27	22.24
16	M2547HB-16	17.78	24.78
18	M2547HB-18	20.32	27.32
20	M2547HB-20	22.86	29.86
22	M2547HB-22	25.40	32.40
24	M2547HB-24	27.94	34.94
26	M2547HB-26	30.48	37.48
28	M2547HB-28	33.02	40.02
30	M2547HB-30	35.56	42.56
32	M2547HB-32	38.10	45.10
34	M2547HB-34	40.64	47.64
36	M2547HB-36	43.18	50.18
38	M2547HB-38	45.72	52.72
40	M2547HB-40	48.26	55.26

2010/06/22	A	B		Modify frame format	Jova	Jova Lau
DATE	OLD REV	NEW REV	ECN	DESCRIPTION	CHECK	APPROVAL

GENERAL TOLERANCE	
.X	±0.30
.XX	±0.20
.XXX	±0.10

东莞市翰皓精密电子有限公司
Dongguan HanHao Precision Electronics Co.,Ltd

APPROVAL	CHECK	DRAWN	DATA
Smak	Yu wei	Liu Yan	2010/06/22

PART NO. M2547HB-2*XX			
TITLE 2.54 mm Crimp Style Connectors			
UNIT mm	SCALE 1:	NUMBER 8	REV B

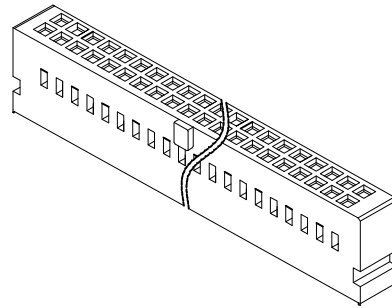
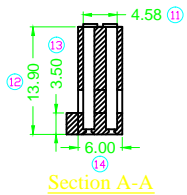
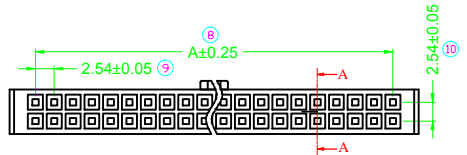
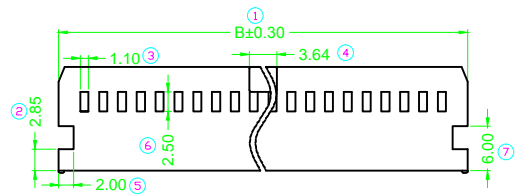

Specifications

- Voltage Rating: 250V AC/ DC
- Current Rating: 3A AC/DC
- Withstanding Voltage: 1500V AC/Minute
- Insulation Resistance: 1000MΩ Min.
- Temperature Range: -25°C~+85°C
- Contact Resistance: 20mΩ Max.

Housing

- Part No.: M2547HC
- Material: PBT UL94V-0
- Suitable HLB M2547T Series Terminal
- Mates with HLB M2547W Series Wafer
- Q'ty: 1,000 Pcs/Bag

Poles	Part No.	Dimensions (mm)	
		A	B
4	M2547HC-2*02	2.54	9.48
6	M2547HC-2*03	5.08	12.02
8	M2547HC-2*04	7.62	14.56
10	M2547HC-2*05	10.16	17.10
12	M2547HC-2*06	12.70	19.64
14	M2547HC-2*07	15.24	22.18
16	M2547HC-2*08	17.78	24.72
18	M2547HC-2*09	20.32	27.26
20	M2547HC-2*10	22.86	29.80
22	M2547HC-2*11	25.40	32.34
24	M2547HC-2*12	27.94	34.88
26	M2547HC-2*13	30.48	37.42
28	M2547HC-2*14	33.02	39.96
30	M2547HC-2*15	35.56	42.50
32	M2547HC-2*16	38.10	45.04
34	M2547HC-2*17	40.64	47.58
36	M2547HC-2*18	43.18	50.12
38	M2547HC-2*19	45.72	52.66
40	M2547HC-2*20	48.26	55.20

Poles	Part No.	Dimensions (mm)	
		A	B
42	M2547HC-2*21	50.80	57.74
44	M2547HC-2*22	53.34	60.28
46	M2547HC-2*23	55.88	62.82
48	M2547HC-2*24	58.42	65.36
50	M2547HC-2*25	60.96	67.90
52	M2547HC-2*26	63.50	70.44
54	M2547HC-2*27	66.04	72.98
56	M2547HC-2*28	68.58	75.52
58	M2547HC-2*29	71.12	78.06
60	M2547HC-2*30	73.66	80.60
62	M2547HC-2*31	76.20	83.14
64	M2547HC-2*32	78.74	85.68

				GENERAL TOLERANCE		东莞市翰皓精密电子有限公司				PART NO. M2547HC-2*XX					
				.X ±0.30		Dongguan HanHao Precision Electronics Co.,Ltd				TITLE 2.54 mm Crimp Style Connectors					
2010/06/22				A B		Modify frame format		Jova Jova Lau		APPROVAL CHECK DRAWN DATA					
DATE	OLD REV	NEW REV	ECN	DESCRIPTION	CHECK	APPROVAL	PROJECT	Smark	Yu wei	Liu Yan	2010/06/22	UNIT mm	SCALE 1:	NUMBER 8	REV B

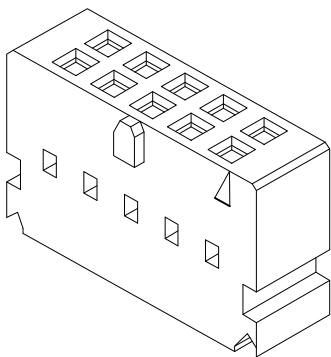
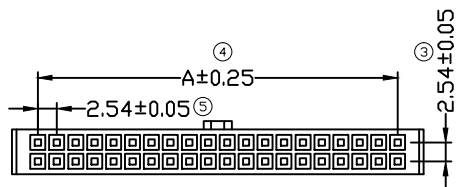
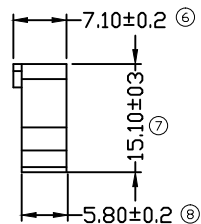
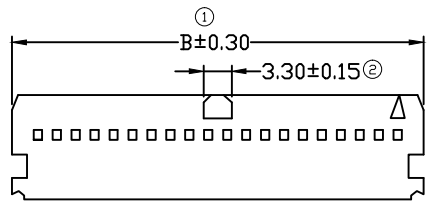

■ Specifications(规格) :

- Voltage rating(额定电压) 250V AC / DC
- Current rating(额定电流):3A AC / DC
- Withstanding voltage(耐压值): 1500V AC/minute
- Temperature range(工作温度): -25°C~+85°C
- Insulation resistance(绝缘电阻): ≥1000MΩ
- Contact resistance(接触电阻): ≤20mΩ
- After environmental testing(环境测试后): ≤30mΩ

■ Housing(胶壳)

- Part No. (料号) :M2547HC1
- Material (材质) :PBT UL 94V-0
- Suitable HLB M2547T Series Terminal (匹配M2547T系列端子)
- Mates With HLB M2547W Series Wafer (匹配M2547W系列针座)
- Q' ty (数量) : 1,000Pcs/Bag/每袋 (1,000Pcs)

Poles	Part No	Dimensions (mm)	
		A	B
4	M2547HC1-04	2.54	9.58
6	M2547HC1-06	5.08	12.12
8	M2547HC1-08	7.62	14.66
10	M2547HC1-10	10.16	17.20
12	M2547HC1-12	12.70	19.74
14	M2547HC1-14	15.24	22.28
16	M2547HC1-16	17.78	24.82
18	M2547HC1-18	20.32	27.36
20	M2547HC1-20	22.86	29.90
22	M2547HC1-22	25.40	32.44
24	M2547HC1-24	27.94	34.98
26	M2547HC1-26	30.48	37.52
28	M2547HC1-28	33.02	40.06
30	M2547HC1-30	35.56	42.60
32	M2547HC1-32	38.10	45.14
34	M2547HC1-34	40.64	47.68
36	M2547HC1-36	43.18	50.22
38	M2547HC1-38	45.72	52.76
40	M2547HC1-40	48.26	55.30
42	M2547HC1-42	50.80	57.84
44	M2547HC1-44	53.34	60.38
46	M2547HC1-46	55.88	62.92
48	M2547HC1-48	58.42	65.46
50	M2547HC1-50	60.96	68.00
52	M2547HC1-52	63.50	70.54
54	M2547HC1-54	66.04	73.08
56	M2547HC1-56	68.58	75.62
58	M2547HC1-58	71.12	78.16
60	M2547HC1-60	73.66	80.70
62	M2547HC1-62	76.20	83.24
64	M2547HC1-64	78.74	85.78

							GENERAL TOLERANCE		东莞市翰皓精密电子有限公司				PART NO.							
							.X ±0.30		Dongguan HanHao Precision Electronics Co.,Ltd				M2547HC1-2*XX							
							.XX ±0.20		APPROVAL				TITLE							
							.XXX ±0.10		Smak		Yu wei		Liu Yan		2010/06/22		2.54 mm Crimp Style Connectors			
							PROJECT		Smak		Yu wei		Liu Yan		2010/06/22		UNIT	SCALE	NUMBER	REV
DATE	OLD REV	NEW REV	ECN	DESCRIPTION	CHECK	APPROVAL	PROJECT	Smak	Yu wei	Liu Yan	2010/06/22	UNIT	SCALE	NUMBER	REV	mm	1:	8	B	

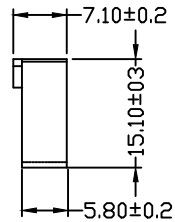
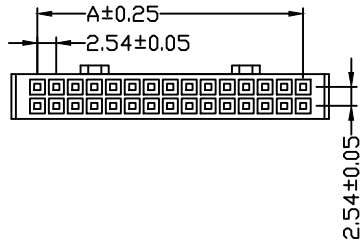
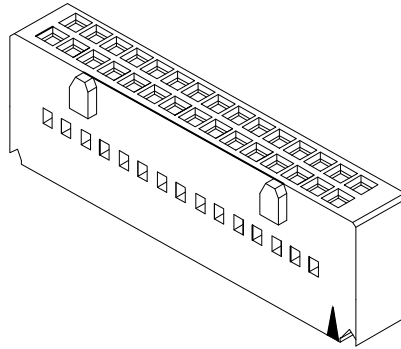
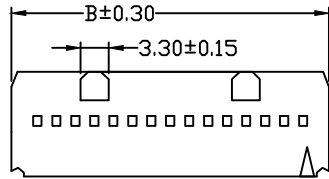

■ Specifications

- Voltage Rating: 250V AC / DC
- Current Rating: 3A AC / DC
- Withstanding Voltage: 1500V AC/minute
- Insulation Resistance: 1000MΩ Min.
- Temperature Range: -25°C~+85°C
- Contact Resistance: 20mΩ Max.

■ Housing

- Part No.: M2547HC2
- Material: PBT UL94V-0
- Suitable HLB M2547T Series Terminal
- Mates With HLB M2547W Series Wafer
- Q'ty: 1,000 Pcs/Bag

Poles	Part No	Dimensions (mm)	
		A	B
4	M2547HC2-04	2.54	9.58
6	M2547HC2-06	5.08	12.12
8	M2547HC2-08	7.62	14.66
10	M2547HC2-10	10.16	17.20
12	M2547HC2-12	12.70	19.74
14	M2547HC2-14	15.24	22.28
16	M2547HC2-16	17.78	24.82
18	M2547HC2-18	20.32	27.36
20	M2547HC2-20	22.86	29.90
22	M2547HC2-22	25.40	32.44
24	M2547HC2-24	27.94	34.98
26	M2547HC2-26	30.48	37.52
28	M2547HC2-28	33.02	40.06
30	M2547HC2-30	35.56	42.60
32	M2547HC2-32	38.10	45.14
34	M2547HC2-34	40.64	47.68
36	M2547HC2-36	43.18	50.22
38	M2547HC2-38	45.72	52.76
40	M2547HC2-40	48.26	55.30

Poles	Part No	Dimensions (mm)	
		A	B
42	M2547HC2-42	50.80	57.84
44	M2547HC2-44	53.34	60.38
46	M2547HC2-46	55.88	62.92
48	M2547HC2-48	58.42	65.46
50	M2547HC2-50	60.96	68.00
52	M2547HC2-52	63.50	70.54
54	M2547HC2-54	66.04	73.08
56	M2547HC2-56	68.58	75.62
58	M2547HC2-58	71.12	78.16
60	M2547HC2-60	73.66	80.70
62	M2547HC2-62	76.20	83.24
64	M2547HC2-64	78.74	85.78

							GENERAL TOLERANCE		东莞市翰皓精密电子有限公司				PART NO. M2547HC2-2*XX			
							.X ±0.30		Dongguan HanHao Precision Electronics Co.,Ltd				TITLE 2.54 mm Crimp Style Connectors			
							.XX ±0.20		APPROVAL		CHECK		DRAWN		DATA	
							.XXX ±0.10		Smark		Yu wei		Liu Yan		2010/06/22	
							PROJECT		UNIT mm		SCALE 1:		NUMBER 8		REV B	
2010/06/22	A	B		Modify frame format	Jova	Jova Lau										
DATE	OLD REV	NEW REV	ECN	DESCRIPTION	CHECK	APPROVAL										

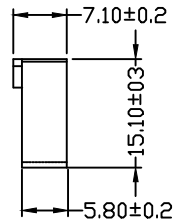
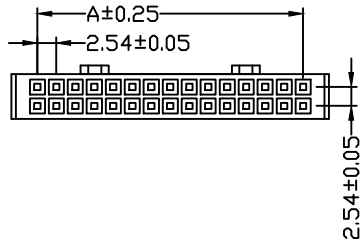
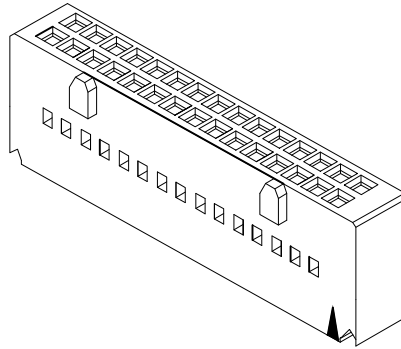
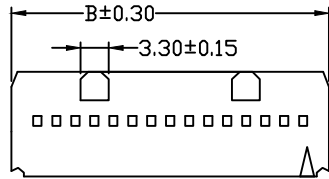

■ Specifications

- Voltage Rating: 250V AC / DC
- Current Rating: 3A AC / DC
- Withstanding Voltage: 1500V AC/minute
- Insulation Resistance: 1000MΩ Min.
- Temperature Range: -25°C~+85°C
- Contact Resistance: 20mΩ Max.

■ Housing

- Part No.: M2547HC2
- Material: PBT UL94V-0
- Suitable HLB M2547T Series Terminal
- Mates With HLB M2547W Series Wafer
- Q'ty: 1,000 Pcs/Bag

Poles	Part No	Dimensions (mm)	
		A	B
4	M2547HC2-04	2.54	9.58
6	M2547HC2-06	5.08	12.12
8	M2547HC2-08	7.62	14.66
10	M2547HC2-10	10.16	17.20
12	M2547HC2-12	12.70	19.74
14	M2547HC2-14	15.24	22.28
16	M2547HC2-16	17.78	24.82
18	M2547HC2-18	20.32	27.36
20	M2547HC2-20	22.86	29.90
22	M2547HC2-22	25.40	32.44
24	M2547HC2-24	27.94	34.98
26	M2547HC2-26	30.48	37.52
28	M2547HC2-28	33.02	40.06
30	M2547HC2-30	35.56	42.60
32	M2547HC2-32	38.10	45.14
34	M2547HC2-34	40.64	47.68
36	M2547HC2-36	43.18	50.22
38	M2547HC2-38	45.72	52.76
40	M2547HC2-40	48.26	55.30

Poles	Part No	Dimensions (mm)	
		A	B
42	M2547HC2-42	50.80	57.84
44	M2547HC2-44	53.34	60.38
46	M2547HC2-46	55.88	62.92
48	M2547HC2-48	58.42	65.46
50	M2547HC2-50	60.96	68.00
52	M2547HC2-52	63.50	70.54
54	M2547HC2-54	66.04	73.08
56	M2547HC2-56	68.58	75.62
58	M2547HC2-58	71.12	78.16
60	M2547HC2-60	73.66	80.70
62	M2547HC2-62	76.20	83.24
64	M2547HC2-64	78.74	85.78

							GENERAL TOLERANCE		东莞市翰皓精密电子有限公司				PART NO. M2547HC2-2*XX			
							.X ±0.30		Dongguan HanHao Precision Electronics Co.,Ltd				TITLE 2.54 mm Crimp Style Connectors			
							.XX ±0.20		APPROVAL		CHECK		DRAWN		DATA	
							.XXX ±0.10		Smark		Yu wei		Liu Yan		2010/06/22	
							PROJECT		UNIT mm		SCALE 1:		NUMBER 8		REV B	
2010/06/22	A	B		Modify frame format	Jova	Jova Lau										
DATE	OLD REV	NEW REV	ECN	DESCRIPTION	CHECK	APPROVAL										

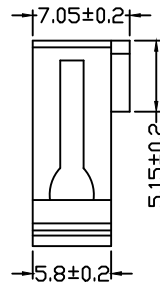
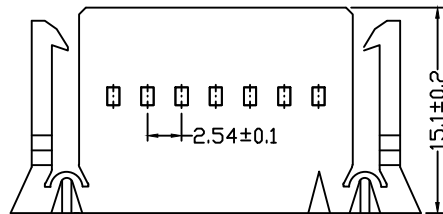
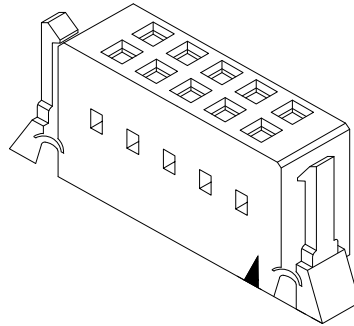
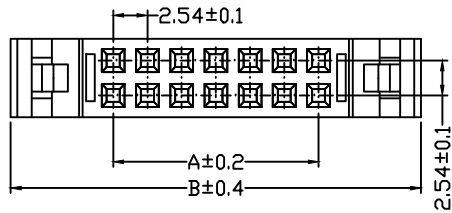

■ SPECIFICATIONS

- Voltage rating: 250V AC, DC
- Current rating: 3A, AC, DC
- Withstanding Voltage: 1500V AC/minute
- Insulation resistance: 1000MΩmin
- Temperature range: -25°C~+85°C
- Contact resistance: Intial value/20mΩmax
- After enviormental testing/20mΩmax

■ HOUSING

- Part No.:M2547HF
- Material:PBT UL94V-0
- Suitable HLB M2547T series Terminal
- Mates with HLB M2547W series Wafer
- Q'ty:1000 pcs/bag

Poles	Part No	Dimensions (mm)	
		A	B
4	M2547HF-04	2.54	9.54
6	M2547HF-06	5.08	12.08
8	M2547HF-08	7.62	14.62
10	M2547HF-10	10.16	17.16
12	M2547HF-12	12.70	19.70
14	M2547HF-14	15.27	22.24
16	M2547HF-16	17.78	24.78
18	M2547HF-18	20.32	27.32
20	M2547HF-20	22.86	29.86
22	M2547HF-22	25.40	32.40
24	M2547HF-24	27.94	34.94
26	M2547HF-26	30.48	37.48
28	M2547HF-28	33.02	40.02
30	M2547HF-30	35.56	42.56
32	M2547HF-32	38.10	45.10
34	M2547HF-34	40.64	47.64
36	M2547HF-36	43.18	50.18
38	M2547HF-38	45.72	52.72
40	M2547HF-40	48.26	55.26

							GENERAL TOLERANCE		东莞市翰皓精密电子有限公司 Dongguan HanHao Precision Electronics Co.,Ltd				PART NO. M2547HF-2*XX			
							.X ±0.30 .XX ±0.20 .XXX ±0.10		APPROVAL				TITLE 2.54 mm Crimp Style Connectors			
							PROJECT		Smark		Yu wei		Liu Yan		2010/06/22	
DATE	OLD REV	NEW REV	ECN	DESCRIPTION	CHECK	APPROVAL	PROJECT		Smark	Yu wei	Liu Yan	2010/06/22	UNIT	SCALE	NUMBER	REV
2010/06/22	A	B	/	Modify frame format	Jova	Jova Lau	PROJECT		mm	1:	8	B				

1 2 3 4 5 6 7 8

F

F

E

E

D

D

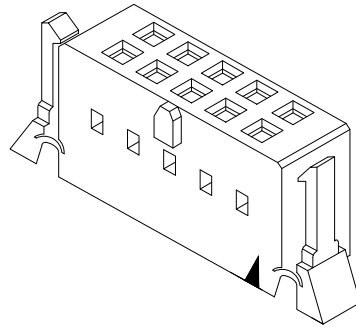
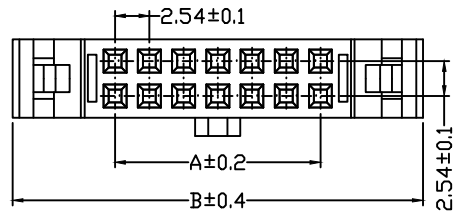

■ SPECIFICATIONS

- Voltage rating: 250V AC, DC
- Current rating: 3A, AC, DC
- Withstanding Voltage: 1500V AC/minute
- Insulation resistance: 1000MΩmin
- Temperature range: -25°C~+85°C
- Contact resistance: Intial value/20mΩmax
- After enviornment testing/20mΩmax

■ HOUSING

- Part No.:M2547HF1
- Material:PBT UL94V-0
- Suitable HLB M2547T series Terminal
- Mates with HLB M2547W series Wafer
- Q'ty:1000 pcs/bag

C

C

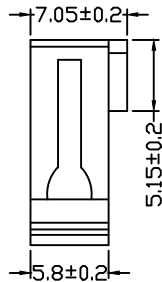
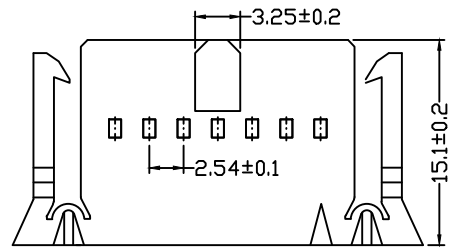

B

B

Poles	Part No	Dimensions (mm)	
		A	B
4	M2547HF1-04	2.54	9.54
6	M2547HF1-06	5.08	12.08
8	M2547HF1-08	7.62	14.62
10	M2547HF1-10	10.16	17.16
12	M2547HF1-12	12.70	19.70
14	M2547HF1-14	15.27	22.24
16	M2547HF1-16	17.78	24.78
18	M2547HF1-18	20.32	27.32
20	M2547HF1-20	22.86	29.86
22	M2547HF1-22	25.40	32.40
24	M2547HF1-24	27.94	34.94
26	M2547HF1-26	30.48	37.48
28	M2547HF1-28	33.02	40.02
30	M2547HF1-30	35.56	42.56
32	M2547HF1-32	38.10	45.10
34	M2547HF1-34	40.64	47.64
36	M2547HF1-36	43.18	50.18
38	M2547HF1-38	45.72	52.72
40	M2547HF1-40	48.26	55.26

A

A

							GENERAL TOLERANCE		东莞市翰皓精密电子有限公司 Dongguan HanHao Precision Electronics Co.,Ltd				PART NO. M2547HF1-2*XX			
							.X ±0.30 .XX ±0.20 .XXX ±0.10		APPROVAL				TITLE 2.54 mm Crimp Style Connectors			
2010/06/22	A	B	/	Modify frame format	Jova	Jova Lau	PROJECT		Smark	Yu wei	Liu Yan	2010/06/22	UNIT	SCALE	NUMBER	REV
DATE	OLD REV	NEW REV	ECN	DESCRIPTION	CHECK	APPROVAL	PROJECT		Smark	Yu wei	Liu Yan	2010/06/22	mm	1:	8	B

1 2 3 4 5 6 7 8

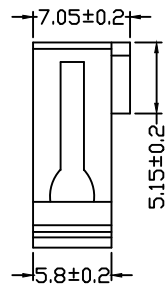
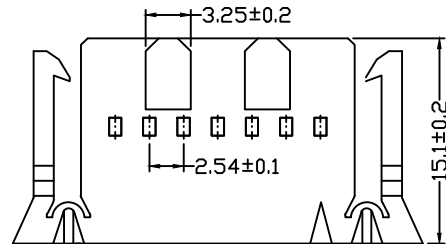
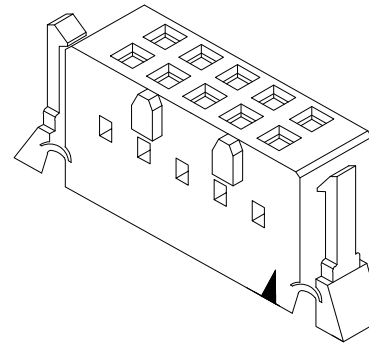
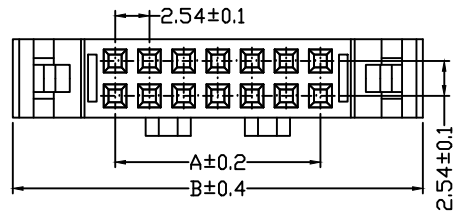

Poles	Part No	Dimensions (mm)	
		A	B
4	M2547HF2-04	2.54	9.54
6	M2547HF2-06	5.08	12.08
8	M2547HF2-08	7.62	14.62
10	M2547HF2-10	10.16	17.16
12	M2547HF2-12	12.70	19.70
14	M2547HF2-14	15.27	22.24
16	M2547HF2-16	17.78	24.78
18	M2547HF2-18	20.32	27.32
20	M2547HF2-20	22.86	29.86
22	M2547HF2-22	25.40	32.40
24	M2547HF2-24	27.94	34.94
26	M2547HF2-26	30.48	37.48
28	M2547HF2-28	33.02	40.02
30	M2547HF2-30	35.56	42.56
32	M2547HF2-32	38.10	45.10
34	M2547HF2-34	40.64	47.64
36	M2547HF2-36	43.18	50.18
38	M2547HF2-38	45.72	52.72
40	M2547HF2-40	48.26	55.26

■ SPECIFICATIONS

- Voltage rating: 250V AC, DC
- Current rating: 3A, AC, DC
- Withstanding Voltage: 1500V AC/minute
- Insulation resistance: 1000MΩmin
- Temperature range: -25°C~+85°C
- Contact resistance: Intial value/20mΩmax
- After enviornmental testing/20mΩmax

■ HOUSING

- Part No.:M2547HF
- Material:PBT UL94V-0
- Suitable HLB M2547T series Terminal
- Mates with HLB M2547W series Wafer
- Q'ty:1000 pcs/bag

							GENERAL TOLERANCE		东莞市翰皓精密电子有限公司				PART NO. M2547HF2-2*XX			
							.X ±0.30		Dongguan HanHao Precision Electronics Co.,Ltd				TITLE 2.54 mm Crimp Style Connectors			
							.XX ±0.20		APPROVAL		CHECK		DRAWN		DATA	
							.XXX ±0.10		Smark		Yu wei		Liu Yan		2010/06/22	
							PROJECT		UNIT mm		SCALE 1:		NUMBER 8		REV B	
2010/06/22	A	B		Modify frame format	Jova	Jova Lau	PROJECT		UNIT mm		SCALE 1:		NUMBER 8		REV B	
DATE	OLD REV	NEW REV	ECN	DESCRIPTION	CHECK	APPROVAL	PROJECT		UNIT mm		SCALE 1:		NUMBER 8		REV B	

1 2 3 4 5 6 7 8

F
E
D
C
B
A

F
E
D
C
B
A

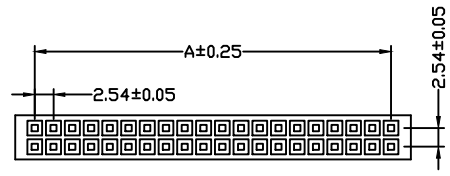
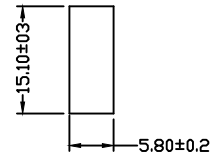
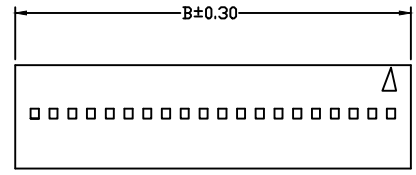

■ SPECIFICATIONS

- Voltage Rating: 250V AC, DC
- Current Rating: 3A, AC, DC
- Withstanding Voltage: 1500V AC/minute
- Insulation Resistance: 1000MΩmin
- Temperature Range: -25°C~+85°C
- Contact Resistance: 20mΩmax

■ HOUSING

- Part No.: M2547HG
- Material: PBT UL94V-0
- Q'ty: 1000 pcs/bag

Poles	Part No	Dimensions (mm)	
		A	B
4	M2547HG -04	2.54	9.58
6	M2547HG -06	5.08	12.12
8	M2547HG -08	7.62	14.66
10	M2547HG -10	10.16	17.20
12	M2547HG -12	12.70	19.74
14	M2547HG -14	15.24	22.28
16	M2547HG -16	17.78	24.82
18	M2547HG -18	20.32	27.36
20	M2547HG -20	22.86	29.90
22	M2547HG -22	25.40	32.44
24	M2547HG -24	27.94	34.98
26	M2547HG -26	30.48	37.52
28	M2547HG -28	33.02	40.06
30	M2547HG -30	35.56	42.60
32	M2547HG -32	38.10	45.14
34	M2547HG -34	40.64	47.68
36	M2547HG -36	43.18	50.22
38	M2547HG -38	45.72	52.76
40	M2547HG -40	48.26	55.30

Poles	Part No	Dimensions (mm)	
		A	B
42	M2547HG -42	50.80	57.84
44	M2547HG -44	53.34	60.38
46	M2547HG -46	55.88	62.92
48	M2547HG -48	58.42	65.46
50	M2547HG -50	60.96	68.00
52	M2547HG -52	63.50	70.54
54	M2547HG -54	66.04	73.08
56	M2547HG -56	68.58	75.62
58	M2547HG -58	71.12	78.16
60	M2547HG -60	73.66	80.70
62	M2547HG -62	76.20	83.24
64	M2547HG -64	78.74	85.78

							GENERAL TOLERANCE	东莞市翰皓精密电子有限公司 Dongguan HanHao Precision Electronics Co.,Ltd				PART NO. M2547HG-2*XX			
							.X ±0.30	APPROVAL				TITLE 2.54 mm Crimp Style Connectors			
							.XX ±0.20	CHECK				UNIT			
							.XXX ±0.10	DRAWN				SCALE			
							PROJECT				NUMBER				
DATE	OLD REV	NEW REV	ECN	DESCRIPTION	CHECK	APPROVAL	DATA				REV				
2010/06/22	A	B	/	Modify frame format	Jova	Jova Lau	Smak	Yu wei	Liu Yan	2010/06/22	mm	1:	8	B	

1 2 3 4 5 6 7 8

1 2 3 4 5 6 7 8

F
E
D
C
B
A

F
E
D
C
B
A

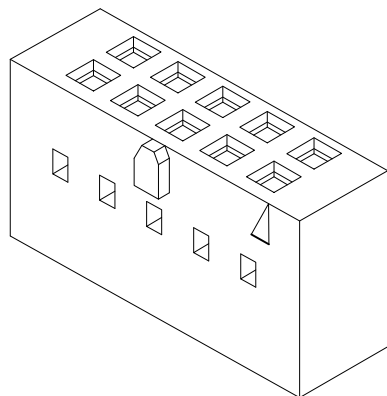

SPECIFICATIONS

- Voltage Rating: 250V AC, DC
- Current Rating: 3A, AC, DC
- Withstanding Voltage: 1500V AC/minute
- Insulation Resistance: 1000MΩmin
- Temperature Range: -25°C~+85°C
- Contact Resistance: 20mΩmax

HOUSING

- Part No.: M2547HG1
- Material: PBT UL94V-0
- Suitable HLB M2547T series Terminal Mates with HLB M2547W series Wafer
- Q'ty: 1000 pcs/bag

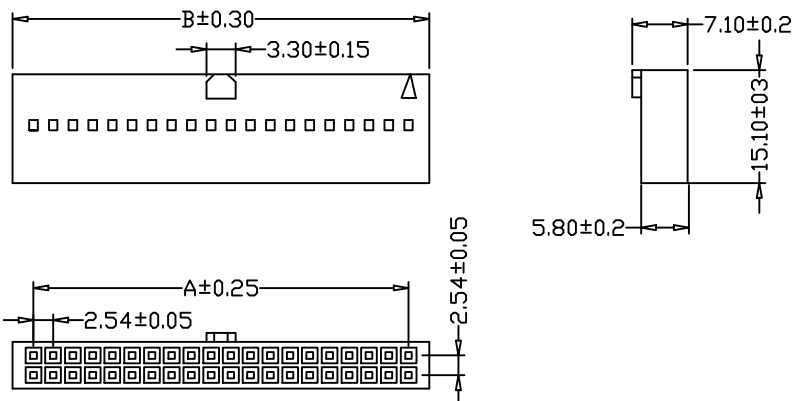

Poles	Part No	Dimensions (mm)	
		A	B
4	M2547HG1-04	2.54	9.58
6	M2547HG1-06	5.08	12.12
8	M2547HG1-08	7.62	14.66
10	M2547HG1-10	10.16	17.20
12	M2547HG1-12	12.70	19.74
14	M2547HG1-14	15.24	22.28
16	M2547HG1-16	17.78	24.82
18	M2547HG1-18	20.32	27.36
20	M2547HG1-20	22.86	29.90
22	M2547HG1-22	25.40	32.44
24	M2547HG1-24	27.94	34.98
26	M2547HG1-26	30.48	37.52
28	M2547HG1-28	33.02	40.06
30	M2547HG1-30	35.56	42.60
32	M2547HG1-32	38.10	45.14
34	M2547HG1-34	40.64	47.68
36	M2547HG1-36	43.18	50.22
38	M2547HG1-38	45.72	52.76
40	M2547HG1-40	48.26	55.30

Poles	Part No	Dimensions (mm)	
		A	B
42	M2547HG1-42	50.80	57.84
44	M2547HG1-44	53.34	60.38
46	M2547HG1-46	55.88	62.92
48	M2547HG1-48	58.42	65.46
50	M2547HG1-50	60.96	68.00
52	M2547HG1-52	63.50	70.54
54	M2547HG1-54	66.04	73.08
56	M2547HG1-56	68.58	75.62
58	M2547HG1-58	71.12	78.16
60	M2547HG1-60	73.66	80.70
62	M2547HG1-62	76.20	83.24
64	M2547HG1-64	78.74	85.78

						GENERAL TOLERANCE .X ±0.30 .XX ±0.20 .XXX ±0.10				东莞市翰皓精密电子有限公司 Dongguan HanHao Precision Electronics Co.,Ltd				PART NO. M2547HG1-2*XX			
2010/06/22				A B		Modify frame format				Jova Jova Lau				TITLE 2.54 mm Crimp Style Connectors			
DATE	OLD REV	NEW REV	ECN	DESCRIPTION	CHECK	APPROVAL	PROJECT	Smark	Yu wei	Liu Yan	2010/06/22	UNIT	SCALE	NUMBER	REV		
1												mm	1:	8	B		

1 2 3 4 5 6 7 8

1 2 3 4 5 6 7 8

F

F

E

E

D

D

C

C

B

B

A

A

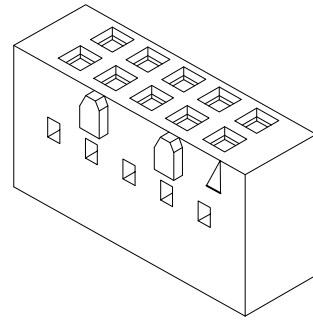

□ SPECIFICATIONS

- Voltage Rating: 250V AC, DC
- Current Rating: 3A, AC, DC
- Withstanding Voltage: 1500V AC/minute
- Insulation Resistance: 1000MΩmin
- Temperature Range: -25°C~+85°C
- Contact Resistance: 20mΩmax

□ HOUSING

- Part No.: M2547HG2
- Material: PBT UL94V-0
- Suitable HLB M2547T series Terminal
- Mates with HLB M2547W series Wafer
- Q'ty: 1000 pcs/bag

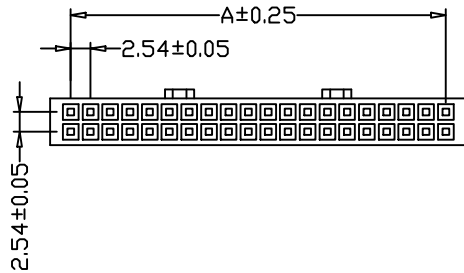
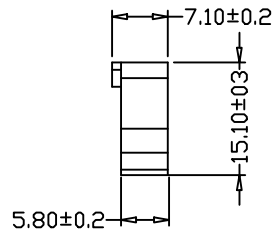
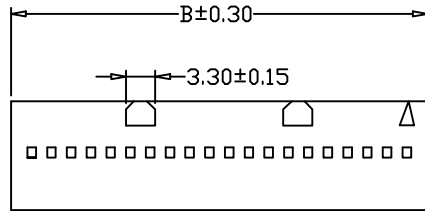

Poles	Part No	Dimensions (mm)	
		A	B
4	M2547HG2 -04	2.54	9.58
6	M2547HG2 -06	5.08	12.12
8	M2547HG2 -08	7.62	14.66
10	M2547HG2 -10	10.16	17.20
12	M2547HG2 -12	12.70	19.74
14	M2547HG2 -14	15.24	22.28
16	M2547HG2 -16	17.78	24.82
18	M2547HG2 -18	20.32	27.36
20	M2547HG2 -20	22.86	29.90
22	M2547HG2 -22	25.40	32.44
24	M2547HG2 -24	27.94	34.98
26	M2547HG2 -26	30.48	37.52
28	M2547HG2 -28	33.02	40.06
30	M2547HG2 -30	35.56	42.60
32	M2547HG2 -32	38.10	45.14
34	M2547HG2 -34	40.64	47.68
36	M2547HG2 -36	43.18	50.22
38	M2547HG2 -38	45.72	52.76
40	M2547HG2 -40	48.26	55.30

Poles	Part No	Dimensions (mm)	
		A	B
42	M2547HG2 -42	50.80	57.84
44	M2547HG2 -44	53.34	60.38
46	M2547HG2 -46	55.88	62.92
48	M2547HG2 -48	58.42	65.46
50	M2547HG2 -50	60.96	68.00
52	M2547HG2 -52	63.50	70.54
54	M2547HG2 -54	66.04	73.08
56	M2547HG2 -56	68.58	75.62
58	M2547HG2 -58	71.12	78.16
60	M2547HG2 -60	73.66	80.70
62	M2547HG2 -62	76.20	83.24
64	M2547HG2 -64	78.74	85.78

				GENERAL TOLERANCE		东莞市翰皓精密电子有限公司				PART NO. M2547HG2-2*XX					
				.X ±0.30		Dongguan HanHao Precision Electronics Co.,Ltd				TITLE 2.54 mm Crimp Style Connectors					
2010/06/22				A B		Modify frame format				Jova Jova Lau					
DATE				OLD REV		NEW REV		ECN		DESCRIPTION		CHECK		APPROVAL	
1				2		3		4		PROJECT		Smark Yu wei Liu Yan		2010/06/22	
1				2		3		4		UNIT mm		SCALE 1:		NUMBER 8	
1				2		3		4		REV B					

1 2 3 4 5 6 7 8