

环保物料

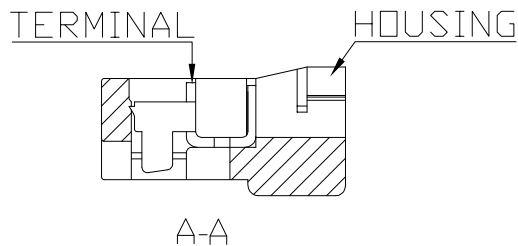
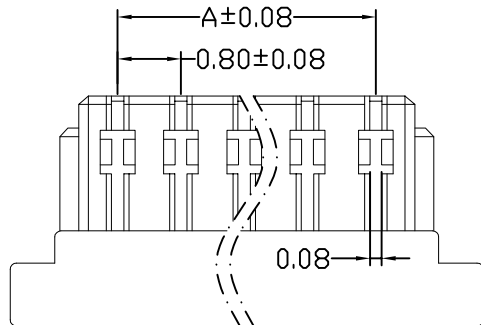
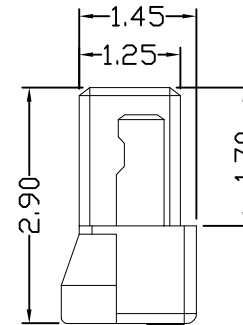
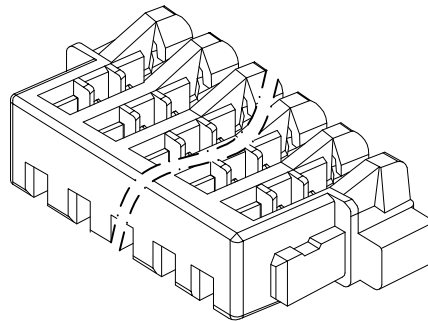
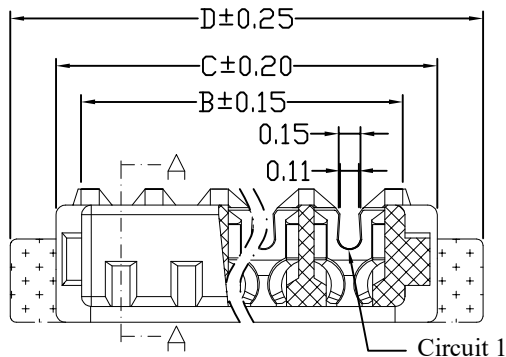

■ Specifications(规格) :

- Voltage rating(额定电压): 30V AC / DC
- Current rating(额定电流): 0.5A AC / DC
- Withstanding voltage(耐压值): 200V AC/minute
- Temperature range(工作温度): -25°C~+85°C
- Insulation resistance(绝缘电阻): ≥100MΩ
- Contact resistance(接触电阻): ≤20mΩ
- After environmental testing(环境测试后): ≤40mΩ

■ Housing(胶壳)

- Part No. (料号): J0800GEH00-XXP
- Wire Range (适用的线材): AWG#32-34
Insulation O.D(绝缘O.D): ≤0.38mm
- Poles (PIN数): 02-24
- Material (材质): Nylon 6T (尼龙6T) UL 94V-0
Pin针: Phosphor Bronze (磷青铜)
Finish (电镀): Gold-Flash (镀金)
- Mates With HLB J0800WV、J0800WR Series Wafer
(匹配J0800WV、J0800WR90系列针座)
- Q' ty (数量): 1,000Pcs/Bag/每袋 (1,000Pcs)

Poles	PART NO.	Dimensions (mm)			
		A	B	C	D
2	J0800GEH-02P	0.80	1.78	2.40	3.20
3	J0800GEH-03P	1.60	2.58	3.20	4.00
4	J0800GEH-04P	2.40	3.38	4.00	4.80
5	J0800GEH-05P	3.20	4.18	4.80	5.60
6	J0800GEH-06P	4.00	4.98	5.60	6.40
7	J0800GEH-07P	4.80	5.78	6.40	7.20
8	J0800GEH-08P	5.60	6.58	7.20	8.00
9	J0800GEH-09P	6.40	7.38	8.00	8.80
10	J0800GEH-10P	7.20	8.18	8.80	9.60
11	J0800GEH-11P	8.00	8.98	9.60	10.40
12	J0800GEH-12P	8.80	9.78	10.40	11.20
13	J0800GEH-13P	9.60	10.58	11.20	12.00
14	J0800GEH-14P	10.40	11.38	12.00	12.80
15	J0800GEH-15P	11.20	12.18	12.80	13.60
16	J0800GEH-16P	12.00	12.98	13.60	14.40
17	J0800GEH-17P	12.80	13.78	14.40	15.20
18	J0800GEH-18P	13.60	14.58	15.20	16.00
19	J0800GEH-19P	14.40	15.38	16.00	16.80
20	J0800GEH-20P	15.20	16.18	16.80	17.60
21	J0800GEH-21P	16.00	16.98	17.60	18.40
22	J0800GEH-22P	16.80	17.78	18.40	19.20
23	J0800GEH-23P	17.60	18.58	19.20	20.00
24	J0800GEH-24P	18.40	19.38	20.00	20.80

				一般公差 GENERAL TOLERANCE				东莞市翰皓精密电子有限公司 Dongguan Han Hao Precision Electronics Co.,Ltd.				料号 PART NO J0800GEH-XX			
				.X ±0.3 .XX ±0.2 .XXX ±0.1								品名 TITLE 0.8 mm Crimp Style connectors			
2011/05/14	A	B	修改图框格式					核准 APPD	审核 CHK	绘图 DR	日期 DATA	单位 UNIT	比例 SCALE	图号 NUMBER	版次 REV
日期 DATE	旧版次 OLD REV	新版次 NEW REV	变更内容 DESCRIPTION	审核 CHK	核准 APPD	角法 PROJECT	SUCCESS	刘艳	2007/05/03	MM	1/1	A-084	B		

环保物料

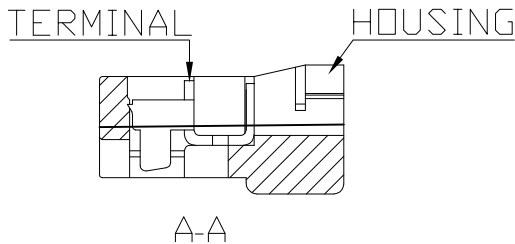
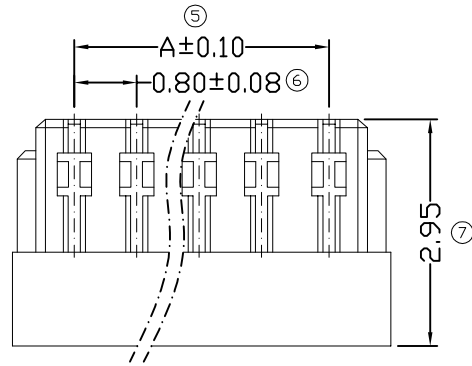
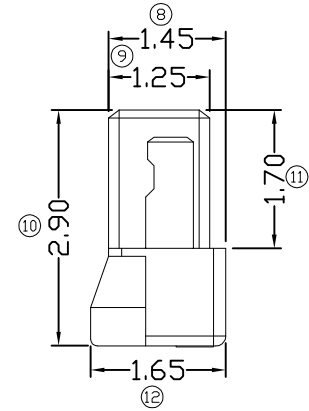
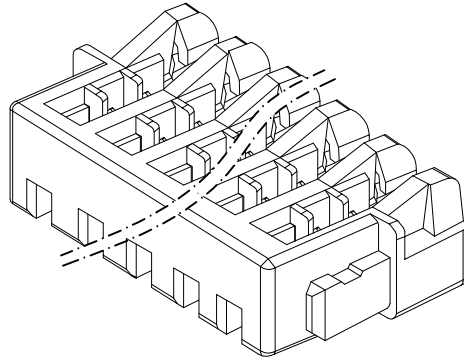
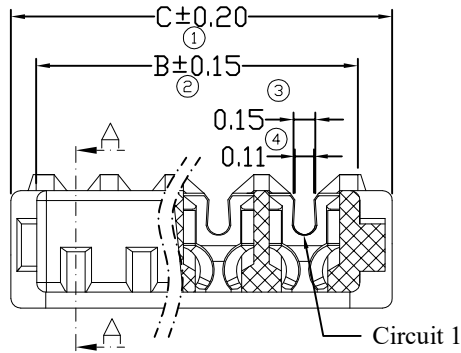

■ Specifications(规格):

- Voltage rating(额定电压): 30V AC / DC
- Current rating(额定电流): 0.5A AC / DC
- Withstanding voltage(耐压值): 200V AC/minute
- Temperature range(工作温度): -25°C~+85°C
- Insulation resistance(绝缘电阻): $\geq 100M\Omega$
- Contact resistance(接触电阻): $\leq 20m\Omega$
- After environmental testing(环境测试后): $\leq 40m\Omega$

■ Housing(胶壳)

- Part No. (料号): J0800H-XXP
- Wire Range (适用的线材): AWG#32-34
Insulation O.D(绝缘O.D): $\leq 0.38mm$
- Poles (PIN数): 02-24
- Material (材质): Nylon 6T (尼龙6T) UL 94V-0
Pin针: Phosphor Bronze (磷青铜)
Finish (电镀): Tin-Plated (镀锡)
- Mates With HHB J0800WV、J0800WR Series Wafer
(匹配J0800W、J0800WR系列针座)
- Q'ty (数量): 1,000Pcs/Bag/每袋 (1,000Pcs)

Poles	PART NO.	Dimensions (mm)		
		A	B	C
2	J0800H-02P	0.80	1.78	2.40
3	J0800H-03P	1.60	2.58	3.20
4	J0800H-04P	2.40	3.38	4.00
5	J0800H-05P	3.20	4.18	4.80
6	J0800H-06P	4.00	4.98	5.60
7	J0800H-07P	4.80	5.78	6.40
8	J0800H-08P	5.60	6.58	7.20
9	J0800H-09P	6.40	7.38	8.00
10	J0800H-10P	7.20	8.18	8.80
11	J0800H-11P	8.00	8.98	9.60
12	J0800H-12P	8.80	9.78	10.40
13	J0800H-13P	9.60	10.58	11.20
14	J0800H-14P	10.40	11.38	12.00
15	J0800H-15P	11.20	12.18	12.80
16	J0800H-16P	12.00	12.98	13.60
17	J0800H-17P	12.80	13.78	14.40
18	J0800H-18P	13.60	14.58	15.20
19	J0800H-19P	14.40	15.38	16.00
20	J0800H-20P	15.20	16.18	16.80
21	J0800H-21P	16.00	16.98	17.60
22	J0800H-22P	16.80	17.78	18.40
23	J0800H-23P	17.60	18.58	19.20
24	J0800H-24P	18.40	19.38	20.00

				一般公差 GENERAL TOLERANCE				东莞市翰皓精密电子有限公司 Dongguan HanHao Precision Electronics Co.,Ltd				料号 PART NO J0800H-XXP			
				.X ±0.3 .XX ±0.2 .XXX ±0.1				核准 APPD 审核 CHK 绘图 DR 日期 DATA				品名 TITLE 0.8 mm Crimp Style connectors			
2011/05/14	A	B	修改图框格式					SUCCESS 刘艳 2007/05/03				单位 UNIT 比例 SCALE 图号 NUMBER 版次 REV MM 1/1 A-106 B			
日期 DATE	旧版次 OLD REV	新版次 NEW REV	变更内容 DESCRIPTION	审核 CHK	核准 APPD	角法 PROJECT									

RoHS  Lead-free

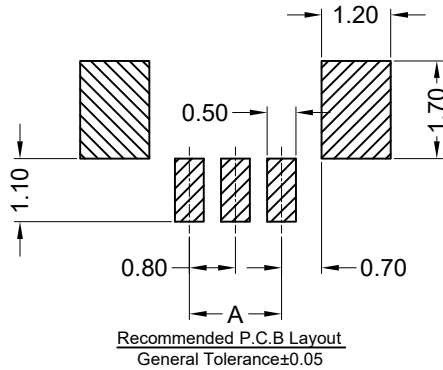
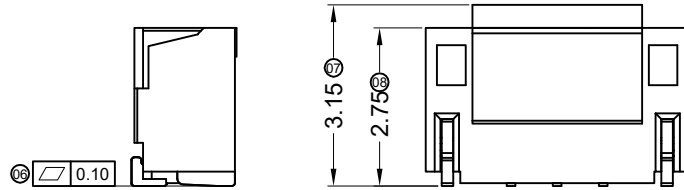
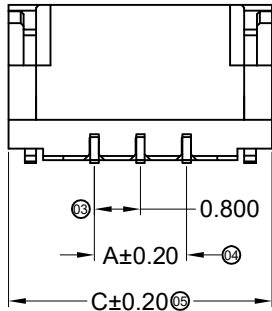
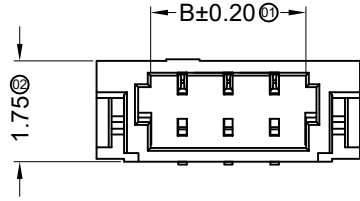
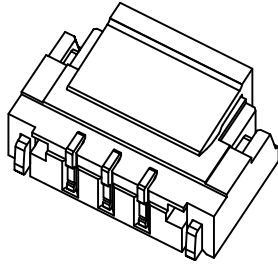
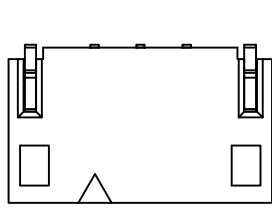

■ Specifications :

- Voltage rating: 30V AC / DC
- Current rating: 0.5A AC / DC
- Withstanding voltage: 200V AC/minute
- Temperature range: -25°C~+85°C
- Insulation resistance: ≥100MΩ
- Contact resistance: ≤20mΩ
- After environmental testing: ≤40mΩ

Poles	Dimensions (mm)			Poles	Dimensions (mm)		
	A	B	C		A	B	C
02	0.80	1.90	3.78	12	8.80	9.90	11.78
03	1.60	2.70	4.58	13	9.60	10.70	12.58
04	2.40	3.50	5.38	14	10.40	11.50	13.38
05	3.20	4.30	6.18	15	11.20	12.30	14.18
06	4.00	5.10	6.98	16	12.00	13.10	14.98
07	4.80	5.90	7.78	17	12.80	13.90	15.78
08	5.60	6.70	8.58	18	13.60	14.70	16.58
09	6.40	7.50	9.38	19	14.40	15.50	17.38
10	7.20	8.30	10.18	20	15.20	16.30	18.18
11	8.00	9.10	10.98				

J0800WSG-XX	LCP UL 94V-0	Phosphor Bronze	Gold-Flash	Phosphor Bronze	Gold-Flash
J0800WS-XX			Tin-Plated		Tin-Plated
PART NO	Material	Material(Pin)	Finish(Pin)	Material (Solder Tabs)	Finish (Solder Tabs)

DATE	OLD REV	NEW REV	ECN	DESCRIPTION	CHECK	APPROVAL	PROJECT	APPROVAL	CHECK	DRAWN	DATA	UNIT	SCALE	NUMBER	REV
							GENERAL TOLERANCE					MM	1:1	A-016	A
							X ±0.30								
							.XX ±0.20								
							.XXX ±0.10								

东莞市翰皓精密电子有限公司

DONGGUAN HANHAO PRECISION ELECTRONIC CO.,LTD

PART NO. J0800WS-XX

TITLE 0.80 mm IDC Style Connectors

APPROVAL: Jacky, CHECK: Jacky, DRAWN: Sylvia, DATA: 2015/08/17

环保物料

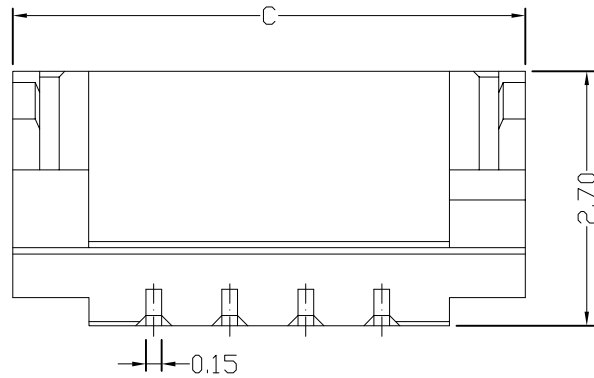
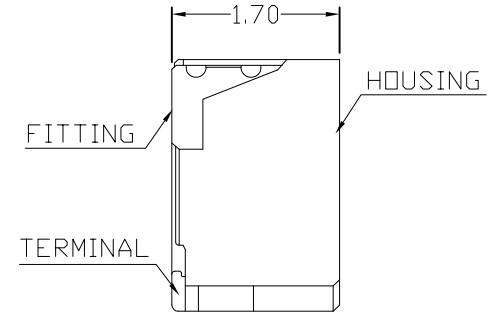
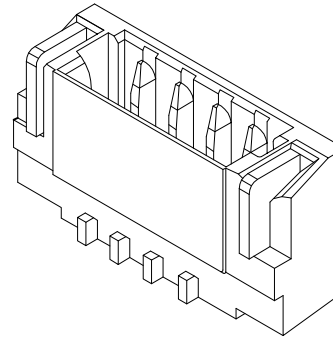
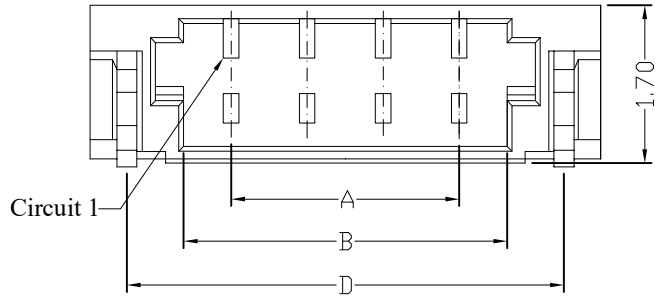

■ Specifications(规格) :

- Voltage rating(额定电压) : 100V AC / DC
- Current rating(额定电流) : 1A AC / DC
- Withstanding voltage(耐压值) : 500V AC/minute
- Temperature range(工作温度) : -25°C~+85°C
- Insulation resistance(绝缘电阻) : $\geq 500M\Omega$
- Contact resistance(接触电阻) : $\leq 20m\Omega$
- After environmental testing(环境测试后) : $\leq 40m\Omega$

■ Wafer(针座)

- Part No. (料号) : J0800WR-XXP
- Poles (PIN数) : 02-24
- Material (材质) : Housing (胶壳) : Nylon 6T (尼龙6T) UL 94V-0
Pin 针: Phosphor Bronze (磷青铜)
Finish (电镀) : Tin-Plated (镀锡)
Solder Tabs: Brass (黄铜)
Finish (电镀) : Tin-Plated (镀锡)
- Mates With HHB J0800H Series Housing (匹配J0800H系列胶壳)
- Q'ty (数量) : 1,000Pcs/Bag/每袋 (1,000Pcs)

Poles	PART NO.	Dimensions (mm)			
		A	B	C	D
2	J0800WR-02P	0.80	1.90	3.78	3.04
3	J0800WR-03P	1.60	2.70	4.58	3.84
4	J0800WR-04P	2.40	3.50	5.38	4.64
5	J0800WR-05P	3.20	4.30	6.18	5.44
6	J0800WR-06P	4.00	5.10	6.98	6.24
7	J0800WR-07P	4.80	5.90	7.78	7.04
8	J0800WR-08P	5.60	6.70	8.58	7.84
9	J0800WR-09P	6.40	7.50	9.38	8.64
10	J0800WR-10P	7.20	8.30	10.18	9.44
11	J0800WR-11P	8.00	9.10	10.98	10.24
12	J0800WR-12P	8.80	9.90	11.78	11.04
13	J0800WR-13P	9.60	10.70	12.58	11.84
14	J0800WR-14P	10.40	11.50	13.38	12.64
15	J0800WR-15P	11.20	12.30	14.18	13.44
16	J0800WR-16P	12.00	13.10	14.98	14.24
17	J0800WR-17P	12.80	13.90	15.78	15.04
18	J0800WR-18P	13.60	14.70	16.58	15.84
19	J0800WR-19P	14.40	15.50	17.38	16.64
20	J0800WR-20P	15.20	16.30	18.18	17.44
21	J0800WR-21P	16.00	17.10	18.98	18.24
22	J0800WR-22P	16.80	17.90	19.78	19.04
23	J0800WR-23P	17.40	18.70	20.58	19.84
24	J0800WR-24P	18.20	19.50	21.38	20.64

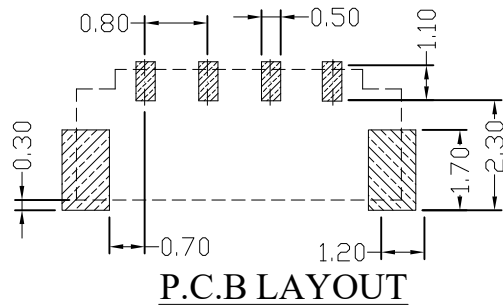

P.C.B LAYOUT

				一般公差 GENERAL TOLERANCE				东莞市翰皓精密电子有限公司 Dongguan HanHao Precision Electronics Co.,Ltd				料号 PART NO J0800WR-XXP			
				. X ±0.3 . XX ±0.2 . XXX ±0.1				核准 APPD 审核 CHK 绘图 DR 日期 DATA				品名 TITLE 0.8 mm Crimp Style connectors			
2011/05/14	A	B	修改图框格式				角法 PROJECT				单位 UNIT 比例 SCALE 图号 NUMBER 版次 REV				
日期 DATE	旧版次 OLD REV	新版次 NEW REV	变更内容 DESCRIPTION				DO SUCCESS 刘艳 2007/05/03				MM 1/1 A-106 B				

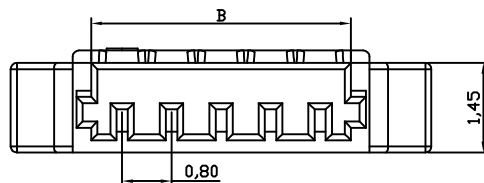
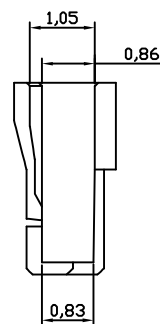
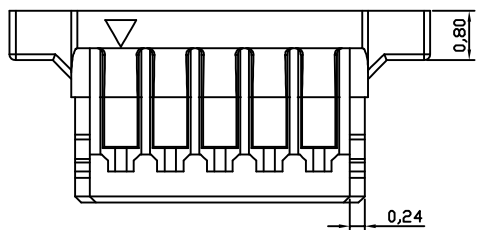
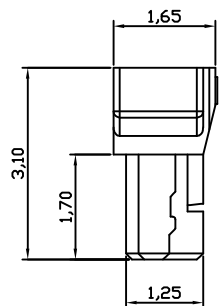
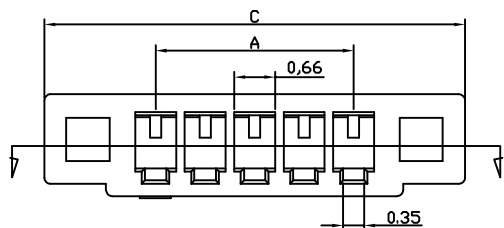
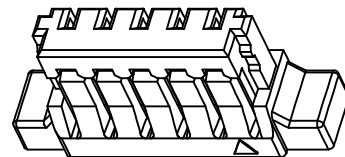
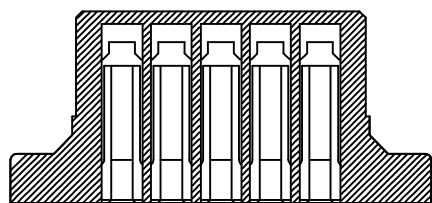

■ Features:

- Part No: J0800HA-XX
- Poles: 02-20
- Material: Nylon 46 UL 94V-0
- Rated Voltage: 30V AC, DC
- Rated Current: 0.5A AC, DC
- Withstanding Voltage: 200V AC/minute
- Contact Resistance: 20MΩ (Max)
- Insulation Resistance: 100MΩ (Min)
- Temperature Range: -25°+85°C

PART NO.	Dimensions			Pcs/Bag
	A	B	C	
02P	0.80	1.80	4.40	1000
03P	1.60	2.60	5.20	1000
04P	2.40	3.40	6.00	1000
05P	3.20	4.20	6.80	1000
06P	4.00	5.00	7.60	1000
07P	4.80	5.80	8.40	1000
08P	5.60	6.60	9.20	1000
09P	6.40	7.40	10.00	1000
10P	7.20	8.20	10.80	1000
11P	8.00	9.00	11.60	1000
12P	8.80	9.80	12.40	1000
13P	9.60	10.60	13.20	1000
14P	10.40	11.40	14.00	1000
15P	11.20	12.20	14.80	1000
16P	12.00	13.00	15.60	1000
17P	12.80	13.80	16.40	1000
18P	13.60	14.60	17.20	1000
19P	14.40	15.40	18.00	1000
20P	15.20	16.20	18.80	1000

				GENERAL TOLERANCE			东莞市翰皓精密电子有限公司				PART NO. J0800HA			
							Dongguan HanHao Precision Electronics Co.,Ltd				TITLE			
2010/06/22				A B			Modify frame format				0.80mm pitch wire to board connector			
DATE				OLD REV NEW REV			DESCRIPTION				UNIT SCALE NUMBER REV			
1				2			3				8			
Jova				Jova Lau			Smark Yu wei Liu Yan				2010/06/22			
2010/06/22				A B			Modify frame format				0.80mm pitch wire to board connector			
DATE				OLD REV NEW REV			DESCRIPTION				UNIT SCALE NUMBER REV			
1				2			3				8			
Jova				Jova Lau			Smark Yu wei Liu Yan				2010/06/22			

GENERAL TOLERANCE
 .X ±0.30
 .XX ±0.20
 .XXX ±0.10

APPROVAL Smark
 CHECK Yu wei
 DRAWN Liu Yan
 DATA 2010/06/22

UNIT mm
 SCALE 1:1
 NUMBER 8
 REV B

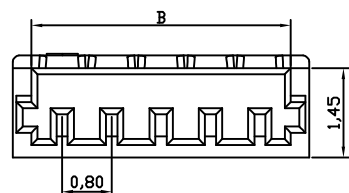
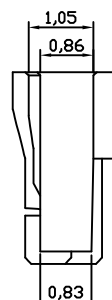
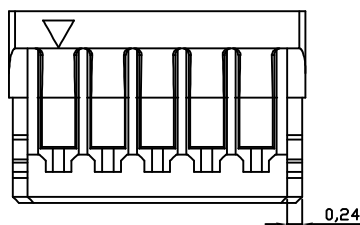
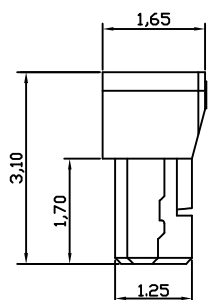
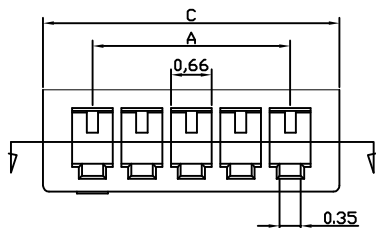
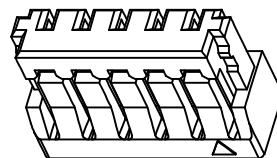
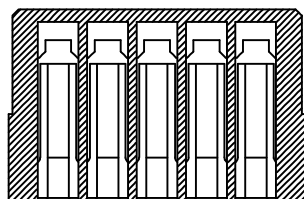

■ Features:

- Part No:J0800HB-XX
- Poles: 02-20
- Material: Nylon 46 UL 94V-0
- Rated Voltage:30V AC,DC
- Rated Current:0.5A AC,DC
- Withstanding Voltage:200V AC/minute
- Contact Resistance:20MΩ (Max)
- Insulation Resistance:100MΩ(Min)
- Temperature Range:-25°+85°C

PART NO.	Dimensions			Pcs/Bag
	A	B	C	
02P	0.80	1.80	2.40	1000
03P	1.60	2.60	3.20	1000
04P	2.40	3.40	4.00	1000
05P	3.20	4.20	4.80	1000
06P	4.00	5.00	5.60	1000
07P	4.80	5.80	6.40	1000
08P	5.60	6.60	7.20	1000
09P	6.40	7.40	8.00	1000
10P	7.20	8.20	8.80	1000
11P	8.00	9.00	9.60	1000
12P	8.80	9.80	10.40	1000
13P	9.60	10.60	11.20	1000
14P	10.40	11.40	12.00	1000
15P	11.20	12.20	12.80	1000
16P	12.00	13.00	13.60	1000
17P	12.80	13.80	14.40	1000
18P	13.60	14.60	15.20	1000
19P	14.40	15.40	16.00	1000
20P	15.20	16.20	16.80	1000

							GENERAL TOLERANCE		东莞市翰皓精密电子有限公司 Dongguan HanHao Precision Electronics Co.,Ltd				PART NO. J0800HB			
							.X ±0.30 .XX ±0.20 .XXX ±0.10						TITLE 0.80mm pitch wire to board connecto			
2010/06/22	A	B		Modify frame format	Jova	Jova Lau	PROJECT	APPROVAL	CHECK	DRAWN	DATA	UNIT	SCALE	NUMBER	REV	
DATE	OLD REV	NEW REV	ECN	DESCRIPTION	CHECK	APPROVAL	☉	Smark	Yu wei	Liu Yan	2010/06/22	mm	1 : 1	8	B	

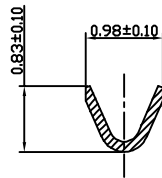
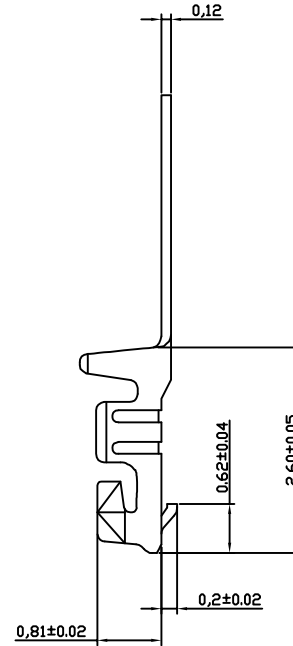
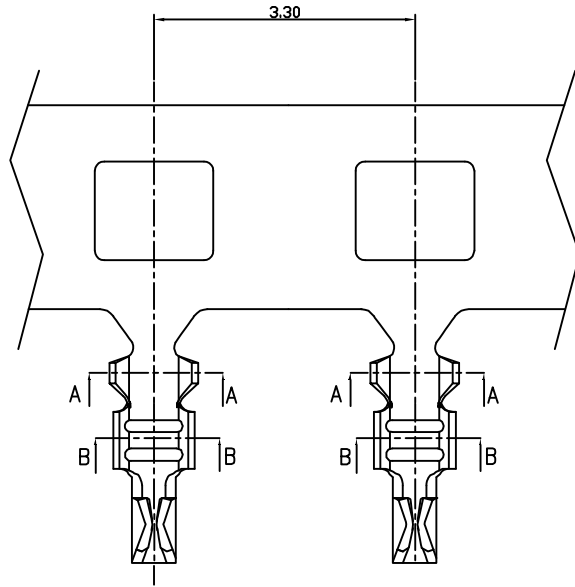

SECTION: B-B

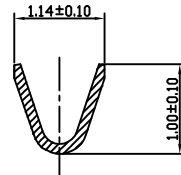

SECTION: A-A

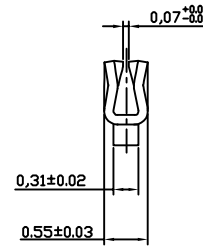

■ Featrues:

- Part No: J0800T
- Used in J0800HA J0800HB
- series socket
- Material : Phosphor Bronze
- Finish: Ni:30-50μ" Sn:70-120μ"
- 盐水喷雾测试时间: 12H

Wire Range	Insulation O.D	Material	Finish	Qty/reel
AWG#32 #34	0.60mm (Max)	Phosphor Bronze	Tin-plated	30 000 pcs

2010/06/22	A	B		Modify frame format	Jova	Jova Lau		
DATE	OLD REV	NEW REV	ECN	DESCRIPTION	CHECK	APPROVAL		

GENERAL TOLERANCE	
.X	±0.30
.XX	±0.20
.XXX	±0.10
PROJECT	

东莞市翰皓精密电子有限公司 Dongguan HanHao Precision Electronics Co.,Ltd			
APPROVAL	CHECK	DRAWN	DATA
Smark	Yu wei	Liu Yan	2010/06/22

PART NO.			
J0800T			
TITLE			
0.80mm pitch crimp terminal			
UNIT	SCALE	NUMBER	REV
mm	1:1	8	B